



Canon

© 2004 CANON INC.

PRINTED IN CHINA

Canon DIGITAL CAMERA PowerShot A310 Camera User Guide

Canon
PowerShot A310
 DIGITAL CAMERA

Camera User Guide

DiG!C



- Please read the *Read This First* section (p. 5).
- Please also see the *Software Starter Guide* and the *Direct Print User Guide*.

Flowchart and Reference Guides

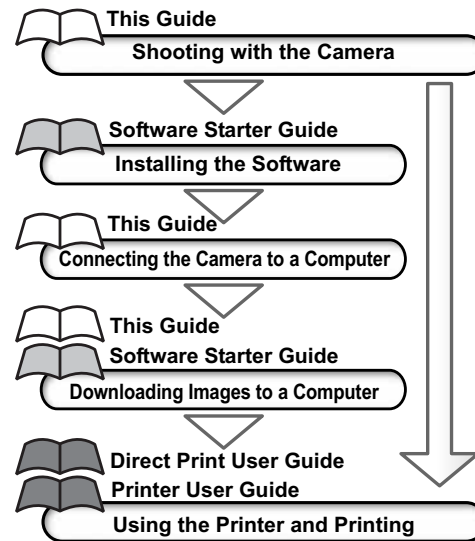

Use of genuine Canon accessories is recommended.

This product is designed to perform optimally when used with genuine Canon accessories. Canon shall not be liable for any damage to this product and/or accidents such as fire, etc., caused by the malfunction of non-genuine Canon accessories (e.g., a leakage and/or explosion of a battery pack). Please note that this warranty does not apply to repairs arising out of the malfunction of non-genuine Canon accessories, although you may request such repairs on a chargeable basis.

Camera Body Temperature

If your camera is used for prolonged periods, the camera body may become warm. Please be aware of this and take care when operating the camera for an extended period.

About the LCD Monitor

The LCD monitor is produced with extremely high-precision manufacturing techniques. More than 99.99% of the pixels operate to specification. Less than 0.01% of the pixels may occasionally misfire or appear as red or black dots.

This has no effect on the recorded image and does not constitute a malfunction.

Language Setting

Please see page 21 to change the language setting.

Please read through the *Read This First* section (p. 5) before using your camera.

Disclaimer





- While every effort has been made to ensure that the information contained in this guide is accurate and complete, no liability can be accepted for any errors or omissions. Canon reserves the right to change the specifications of the hardware and software described herein at any time without prior notice.
- No part of this guide may be reproduced, transmitted, transcribed, stored in a retrieval system, or translated into any language in any form, by any means, without the prior written permission of Canon.
- Canon makes no warranties for damages resulting from corrupted or lost data due to a mistaken operation or malfunction of the camera, the software, the CompactFlash™ cards (CF cards), personal computers, peripheral devices, or use of non-Canon CF cards.

Trademark Acknowledgments

- Canon and PowerShot are trademarks of Canon, Inc.
- CompactFlash is a trademark of SanDisk Corporation.
- iBook and iMac are trademarks of Apple Computer, Inc.
- Macintosh, PowerBook, Power Macintosh and QuickTime are trademarks of Apple Computer, Inc, registered in the United States and other countries.
- Microsoft, Windows, and Windows NT are either registered trademarks or trademarks of Microsoft Corporation in the United States and/or other countries.
- Other names and products not mentioned above may be registered trademarks or trademarks of their respective companies.

Copyright © 2004 Canon Inc. All rights reserved.

Symbols Used

Icons under title bars show the operations mode. As in the example below, the shooting mode should be set to , ,  or .

Using the Flash

Shooting Mode    



This mark denotes issues that may affect the camera's operation.



This mark denotes additional topics that complement the basic operating procedures.

Table of Contents

 : Functions and operations tables. These pages are shaded on the right edges to make them easy to find.

Read this First	5
Please Read	5
Safety Precautions	6
Preventing Malfunctions	11
Components Guide	12
Preparing the Camera	15
Installing the Battery and CF Card	15
Formatting a CF Card	18
Setting the Date/Time	20
Setting the Language	21
Basic Functions	23
Turning the Power On/Off	23
Switching between Shooting/Playback	25
Using the LCD Monitor	26
Shooting – The Basics	31
Auto Mode	31
Reviewing an Image Right After Shooting	34
Selecting a Shooting Mode	35
Changing the Resolution and Compression	36
⚡ Using the Flash	38

Macro/▲ Infinity Modes	40
⌚ Self-timer	41
📷 Continuous Mode	41
Shooting Panoramic Images (Stitch Assist)	42
🎬 Movie Mode	45

Playback – The Basics 47

Displaying Images Individually (Single Image Playback)	47
🔍 Magnifying Images	47
📷 Viewing Images in Sets of Nine (Index Playback) ..	48
Jumping between Images	49
Viewing/Editing Movies	49

Erasing 53

Erasing Single Images	53
Erasing All Images	53

Shooting – Advanced Functions 54

Selecting Menus and Settings	54
Menu Settings and Default Settings	57
Resetting the Settings to Default	62
Shooting Problem Subjects for the Autofocus	63
Switching between Focus Settings	64
Switching between Light Metering Modes	65
Adjusting the Exposure	65
Adjusting the Tone (White Balance)	66

Table of Contents

Changing the ISO Speed.....	69	Specifications	111
Changing the Photo Effect.....	70	Battery Performance	114
Playback – Advanced Functions	72	CF Cards and Estimated Capacities (Recordable Images).....	114
Rotating Images in the Display.....	72	Photo Tips and Information	117
Attaching Sound Memos to Images.....	73	Index	119
Auto Play	74	Functions Available in Each Shooting Mode	124
Protecting Images.....	75		
Various Functions	76		
About Printing	76		
DPOF Print Settings	78		
Image Transmission Settings (DPOF Transfer Order).....	82		
Downloading Images to a Computer	83		
Downloading Directly from a CF card.....	91		
Resetting the File Number	92		
Customizing the Camera (My Camera Settings).....	93		
Registering My Camera Settings.....	94		
List of Messages	98		
Troubleshooting	100		
Appendix	105		
Replacing the Date Battery.....	105		
Using the Power Kits (Sold Separately)	106		
Camera Care and Maintenance	110		

Read This First

Please Read

Test Shots

Before you try to photograph important subjects, we highly recommend that you shoot several trial images to confirm that the camera is operating and being operated correctly. Please note that Canon, its subsidiaries and affiliates, and its distributors are not liable for any consequential damages arising from any malfunction of a camera or accessory, including CompactFlash™ cards, that results in the failure of an image to be recorded or to be recorded in a format that is machine readable.

Warning Against Copyright Infringement

Please note that Canon digital cameras are intended for personal use and should never be used in a manner that infringes upon or contravenes international or domestic copyright laws and regulations. Please be advised that in certain cases the copying of images from performances, exhibitions, or commercial properties by means of a camera or other device may contravene copyright or other legal rights even if the image was shot for personal use.

Warranty Limitations

This camera's warranty is only effective in the country of sale. If a problem arises while the camera is in use abroad, please convey it back to the country of sale before proceeding with a warranty claim to a Canon Customer Support Help Desk.

For Canon Customer Support contacts, please see the Canon Limited Warranty supplied with your camera.

Read This First

Safety Precautions

- Before using the camera, please ensure that you have read and understood the safety precautions described below. Always ensure that the camera is operated correctly.
- The safety precautions noted on the following pages are intended to instruct you in the safe and correct operation of the camera and its accessories to prevent injuries or damage to yourself, other persons and equipment.
- In the next few pages, the term "equipment" refers primarily to the camera, batteries, and separately sold battery and charger kit and compact power adapter.

WARNINGS

- **Do not aim the camera directly into the sun or at other intense light sources which could damage your eyesight.**
- **Do not trigger the flash in close proximity to human or animal eyes.** Exposure to the intense light produced by the flash may damage eyesight. In particular, remain at least one meter (39 inches) away from infants when using the flash.
- **Store this equipment out of the reach of children and infants.** Accidental damage to the camera or batteries by a child could result in serious injury. In addition, placement of the strap around a child's neck could result in asphyxiation.
- **Be particularly careful to keep the date battery used in the camera away from children.** Seek medical assistance immediately if a child swallows a battery.
- **Do not attempt to disassemble or alter any part of the equipment that is not expressly described in this guide.** Disassembly or alteration may result in high-voltage electrical shock. Internal inspections, alterations and repairs should be conducted by qualified service personnel authorized by your camera distributor or a Canon Customer Support Help Desk.
- **To avoid the risk of high-voltage electrical shock, do not touch the flash portion of the camera if it has been damaged.** Similarly, never touch internal portions of the equipment that become exposed as a result of damage. There is a risk of high-voltage electrical shock. Please take the first opportunity to consult your camera distributor or a Canon Customer Support Help Desk.
- **Stop operating the equipment immediately if it emits smoke or noxious fumes.** Failure to do so may result in fire or electrical shock. Immediately turn the camera's power off, remove the camera batteries or unplug the power cord from the power outlet. Confirm that smoke or fume emissions have ceased. Please consult your camera distributor or the closest Canon Customer Support Help Desk.

Read This First

- **Stop operating the equipment if it is dropped or the casing is damaged.** Failure to do so may result in fire or electrical shock. Immediately turn the camera's power off, remove the camera batteries or unplug the power cord from the power outlet. Please consult your camera distributor or the closest Canon Customer Support Help Desk.
- **Do not allow the equipment to come into contact with, or become immersed in, water or other liquids.** Do not allow liquids to enter the interior. The camera has not been waterproofed. If the exterior comes into contact with liquids or salt air, wipe it dry with a soft, absorbent cloth. In the event that water or other foreign substances enter the interior, immediately turn the camera's power off and remove the camera batteries or unplug the power cord from the power outlet. Continued use of the equipment may result in fire or electrical shock. Please consult your camera distributor or the closest Canon Customer Support Help Desk.
- **Do not use substances containing alcohol, benzene, thinners or other flammable substances to clean or maintain the equipment.** The use of these substances may lead to fire.
- **Remove the power cord on a regular periodic basis and wipe away the dust and dirt that collects on the plug, the exterior of the power outlet and the surrounding area.** In dusty, humid or greasy environments, the dust that collects around the plug over long periods of time may become saturated with humidity and short-circuit, leading to fire.
- **Do not cut, damage, alter or place heavy items on the power adapter cord.** Any of these actions may cause an electrical short circuit, which may lead to fire or electrical shock.
- **Do not handle the power cord if your hands are wet.** Handling it with wet hands may lead to electrical shock. When unplugging the cord, ensure that you hold the solid portion of the plug. Pulling on the flexible portion of the cord may damage or expose the wire and insulation, creating the potential for fires or electrical shocks.
- **Use only the recommended power accessories.** Use of power sources not expressly recommended for this equipment may lead to overheating, distortion of the equipment, fire, electrical shock or other hazards.

- **Do not place the batteries near a heat source or expose them to direct flame or heat.** Neither should you immerse them in water. Such exposure may damage the batteries and lead to the leakage of corrosive liquids, fire, electrical shock, explosion or serious injury.
- **Do not attempt to disassemble, alter or apply heat to the batteries.** There is serious risk of injury due to an explosion. Immediately flush with water any area of the body, including the eyes and mouth, skin, or clothing that comes into contact with the inner contents of a battery.
- **Avoid dropping or subjecting the batteries to severe impacts that could damage the casings.** It could lead to leakage and injury.
- **Do not short-circuit the battery terminals with metallic objects, such as key holders.** It could lead to overheating, burns and other injuries.
- **Before you discard a battery, cover the terminals with tape or other insulators to prevent direct contact with other objects.** Contact with the metallic components of other materials in waste containers may lead to fire or explosions. Discard the batteries in specialized waste facilities if available in your area.
- **Use only recommended batteries and accessories.** Use of batteries not expressly recommended for this equipment may cause explosions or leaks, resulting in fire, injury and damage to the surroundings.
- **If using AA-size NiMH batteries, use only Canon AA-size NiMH batteries and the charger recommended for use with these batteries.** Use of another charger may cause batteries to overheat or deform, posing risk of fire or electric shock.
- **Disconnect the battery charger or compact power adapter from both the camera and power outlet after recharging and when the camera is not in use to avoid fires and other hazards.** Continuous use over a long period may cause a unit to overheat and distort, resulting in fire.
- **The camera terminal of the battery charger cord and the compact power cord is designed for exclusive use with your camera.** Do not use it with other products or batteries. There is a risk of fire and other hazards.

Read This First

CAUTIONS

- **Avoid using, placing or storing the equipment in places subject to strong sunlight or high temperatures, such as the dashboard or trunk (boot) of a car.** Exposure to intense sunlight and heat may cause the batteries to leak, overheat or explode, resulting in fire, burns or other injuries. High temperatures may also cause deformation of the casing. Ensure that there is good ventilation when using the battery charger to charge the batteries or power the camera.
- **Do not store the equipment in humid or dusty areas.** Storage in such areas could lead to fire, electrical shock or other damage.
- **Be careful not to bang the camera or subject it to strong impacts or shocks that could lead to injury or damage the equipment when wearing or holding it by the strap.**
- **Be careful not to cover the flash with your fingers or clothing when shooting.** The flash may be damaged and emit smoke or noise. In addition, do not touch the surface of the flash after taking several pictures in rapid succession. Either action could result in burns.
- **Do not operate the flash with dirt, dust or other items stuck to its lens.** The resulting heat build-up could damage the flash.
- **Ensure that the battery charger is plugged into a power outlet of the specified rating, not over the specified rating.** The plug of the battery charger varies according to region.
- **Do not use the battery charger or compact power adapter if the cable or plug is damaged, or if the plug is not fully inserted into the power outlet.**
- **Do not allow metal objects (such as pins or keys) or dirt to contact the charger terminals or plug.**
- **If your camera is used for prolonged periods, the camera body may become warm.** Please take care when operating the camera for an extended period as your hands may experience a burning sensation.

Preventing Malfunctions

Avoid Strong Magnetic Fields

Never place the camera in close proximity to electric motors or other equipment generating strong electromagnetic fields. Exposure to strong magnetic fields may cause malfunctions or corrupt image data.

Avoid Condensation Related Problems

Moving the equipment rapidly between hot and cold temperatures may cause condensation (water droplets) to form on its external and internal surfaces. You can avoid this by placing the equipment in an airtight, resealable plastic bag and letting it adjust to temperature changes slowly before removing it from the bag.

If Condensation Forms Inside the Camera

Stop using the camera immediately if you detect condensation. Continued use may damage the equipment. Remove the CF card and battery or power cord (if connected) from the camera and wait until the moisture evaporates completely before resuming use.

Extended Storage

When not using the camera for extended periods of time, remove the batteries from the camera or battery charger and store the equipment in a safe place. Storing the camera for extended periods with batteries installed will run down the battery and may damage the camera.

Components Guide

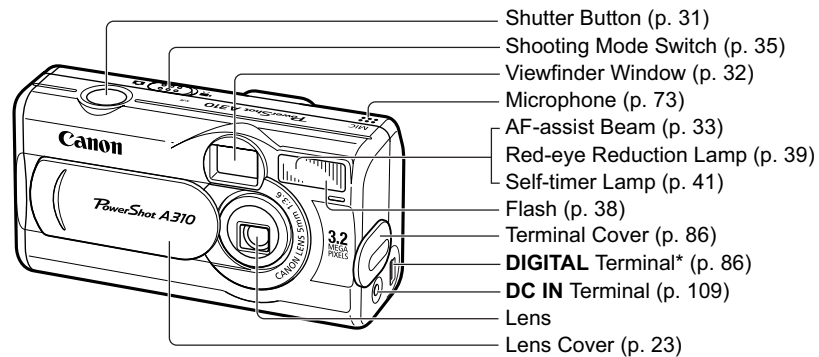

* To connect the camera to a computer or printer, use one of the following cables.

- **Computer:** Interface Cable IFC-400PCU (supplied with the camera)
 - **Direct Print Compatible Printers (Sold Separately)**
 - CP Printers: Interface Cable IFC-400PCU (supplied with the camera) or the Direct Interface Cable DIF-100 (supplied with the CP-100/CP-10)
 - Bubble Jet Printers:
 - *Bubble Jet Direct* Compatible Printers: Please refer to your *Bubble Jet* printer user guide.
 - *PictBridge* Compliant Printers: Interface Cable IFC-400PCU (supplied with the camera)
 - *PictBridge* Compliant Non-Canon Printers: Interface Cable IFC-400PCU (supplied with the camera)
- Please refer to the *System Map* or the *Direct Print User Guide* supplied with the camera for direct print compatible printer information.**

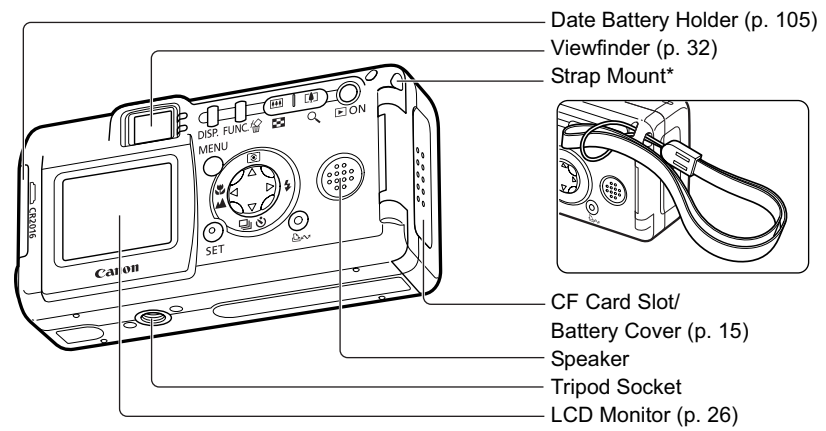

*Be careful when carrying the camera by the strap. Don't swing the camera on the strap, and keep the strap and camera body clear of obstacles.

Components Guide

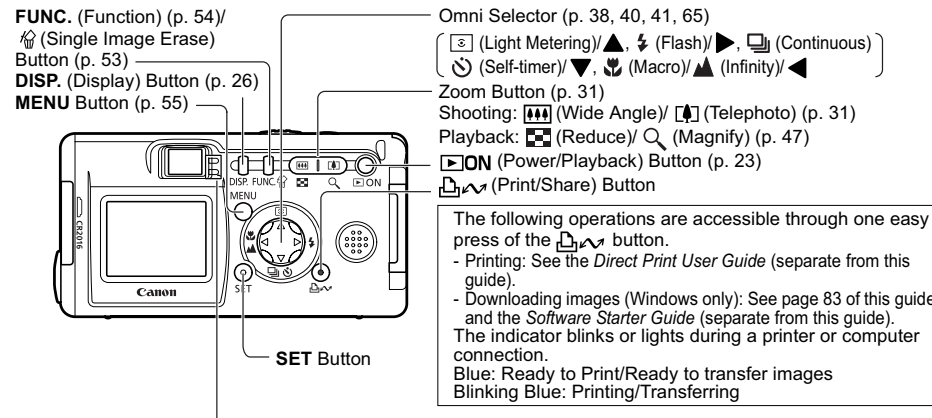

The indicators light or blink when you open the lens cover or whenever you press the shutter button.

Upper Indicator
Green: Ready to shoot or ready to communicate with your computer.
Blinking Green: Starting-up, recording to the CF card, reading the CF card, erasing data on the CF card, or transmitting data to your computer.
Orange: Ready to shoot (using the flash).

Blinking Orange: Ready to shoot (camera shake warning) or charging the flash (with LCD monitor On).
Lower Indicator
Yellow: Macro mode or Infinity mode
Blinking Yellow: Focusing difficulty (although you can press the shutter button, try using focus lock (p. 63))

Preparing the Camera

Installing the Battery and CF Card

Insert two (2) AA-size alkaline batteries (included with the camera) or two (2) AA-size NiMH batteries (sold separately) and insert the CF card.

- 1** Close the lens cover and check that the camera power is off.
- 2** Slide the CF card slot/battery cover and open it.

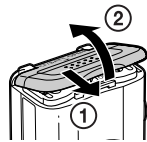

- 3** Press the battery cover lock towards the arrow to open the cover.

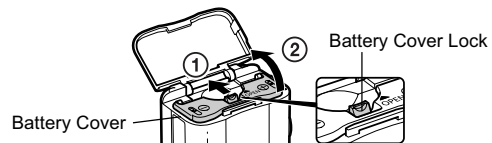

- 4** Insert the batteries as shown and close the battery cover.

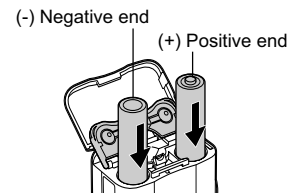

- 5** Insert the CF card as shown and close the CF card slot/battery cover.

- Slide the CF card firmly to the end (to release the CF card, hold onto it and remove.).

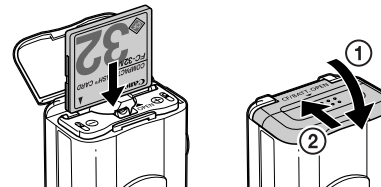



- When the indicator next to the viewfinder blinks green, the camera is writing, reading, erasing, or transmitting an image to or from the CF card. Do not perform the following operations as recorded images may be damaged as a result.
 - Turn the camera off
 - Open the CF card slot/battery cover
 - Shake the camera
- You are recommended to use CF cards that have been formatted in your camera (p. 18). The card supplied with the camera may be used without further formatting.



- We recommend that you use the separately sold AC Adapter Kit ACK800 to power the camera during long usage sessions (p. 109).
- The separately sold battery charger kit lets you use rechargeable NiMH batteries to power the camera (p. 106).
- See *Battery Performance* (p. 114).

- For information about the Battery and Charger Kit and AA-size rechargeable NiMH batteries, see the *System Map* (separate from this guide).
- See *CF Cards and Estimated Capacities (Recordable Images)* (p. 114).

Proper Battery Handling

- Use AA-size alkaline or Canon AA-size NiMH batteries (sold separately) only. For information on handling the AA-size rechargeable NiMH batteries, see *Using the Power Kits (Sold Separately)* (p. 106).
- Never use manganese or lithium batteries, as these battery types may overheat in the camera.
- **Since the performance of alkaline batteries may differ according to brand, the operating time of the batteries you purchase may not be as long as the batteries that came with the camera.**



- Camera operating time may shorten at low temperatures when alkaline batteries are used. Also due to their specifications, alkaline batteries may expire faster than NiMH batteries. If you are using the camera in cold areas or for a long time, we recommend using Canon AA-size NiMH Battery Kit NB4-200 (a 4-battery Kit).
- While it is possible to use AA-size nickel-cadmium batteries, performance is unreliable and their use is not recommended.
- **Never mix unused and partially used batteries. Always load two fresh (or fully recharged) batteries at the same time.**
- **Be careful to load the batteries with their positive (+) and negative (-) ends in the right direction.**
- **Never mix batteries of different types or from different manufacturers. Both batteries should be identical.**
- Before inserting the batteries, wipe the battery terminals well with a dry cloth. Oil from one's skin or other dirt may cause a considerable reduction in the number of recordable images or reduced usage time.
- Battery performance deteriorates at low temperatures (especially with alkaline batteries).

- If you are using the camera in cold areas and batteries are running down faster than they should, you may be able to restore performance by placing batteries in an inner pocket to warm them up prior to use. But be careful that you don't put the batteries into a pocket together with a metal key chain or other metallic objects, as these objects may cause batteries to short-circuit.
- If you do not plan to use the camera for a long time, remove the batteries from the camera and store them in a safe place. Batteries may leak and damage the camera if left installed during prolonged periods of non-use.

WARNINGS

Never use damaged batteries or batteries whose outer seal is completely or partially missing or peeled off, as there is risk that such batteries may leak, overheat, or burst. Always check the seals on store-bought batteries before loading them, as some batteries may come with defective seals. Do not use batteries with defective seals.

Never use batteries that look like this.

-  Batteries with all or part of the seal (electrical insulation sheath) peeled off.
-  The positive electrode (plus terminal) is flat.
-  The negative terminal is correctly formed (protruding from the metal base), but the seal does not extend up over the edge of the metal base.

Battery Status Indications

The LCD monitor displays an icon or message to let you know when batteries are low or depleted.

	Batteries are beginning to run low. Replace (or recharge) batteries promptly. If the LCD monitor is off, this icon will appear when you press any of the following buttons: the omni selector, DISP. button and FUNC. button.
Change the batteries	Batteries are fully depleted and the camera can no longer operate. Replace the batteries immediately.

Formatting a CF Card

You should always format a CF card when you wish to use a new one, or when you wish to delete not only the images in the CF card but also other data.

 Formatting a CF card will permanently erase all data already on it, including all of its protected images. Check the contents before formatting cards that were previously used.

1 Turn the power on (p. 23).

2 Press the MENU button and select [T] (Set up) using ◀ or ▶.



- 3** Select  (Format) using **▲** or **▼** and press the **SET** button.



- 4** Select **[OK]** using **◀** or **▶** and press the **SET** button.



- To cancel formatting instead, select **[Cancel]** and press the **SET** button.
- The capacity of the CF card displayed after formatting will be less than the rated capacity of the CF card. This is not a malfunction of the CF card or camera.

- 5** Press the **MENU** button.



- If the camera is not operating correctly, the CF card may be corrupted. Formatting the card may solve the problem.

- If you are using a CF card from another manufacturer and the card is not functioning correctly, you may be able to correct the problem by formatting the card.
- CF cards formatted with another camera, a computer or peripheral device may not operate correctly. Format these cards with this camera. If formatting in the camera doesn't work properly, turn the camera off and re-insert the CF card. Then turn the camera back on and format again.

About CF Cards

- CF cards are high-precision electronic devices. Do not bend them, apply force to them, or subject them to shocks or vibration.
- Do not attempt to disassemble or alter a CF card.
- Moving a CF card rapidly between temperature extremes will cause condensation to form in the card and lead to a malfunction. To avoid condensation, place the CF card in a sealed plastic bag before moving it into a different temperature zone and allow it to adjust slowly to the new temperature. If condensation forms on

- the CF card, store it at room temperature until the water droplets have evaporated naturally.
- When storing the CF card, use the CF card case.
 - Do not use or store CF cards in the following types of location.
 - Locations subject to dust or sand
 - Locations subject to high humidity and high temperatures

Setting the Date/Time

The Date/Time menu will be displayed when camera power is turned on for the first time or at low date battery power. Perform operations from Step 4 (Replace the date battery when power from the current one is exhausted (p. 105)).

1 Turn the power on (p. 23).

2 Press the MENU button and select the [SET] (Set up) menu using ◀ or ▶.



3 Select [Date/Time] using ▲ or ▼ and then press the SET button.



4 Set the date and time.

- Use ◀ or ▶ to change the value of the highlighted field.
- Press ▲ or ▼ to set the date and time.
- The date can be set up to the year 2030.



5 Press the SET button.

6 Press the MENU button.



- Setting the date and time settings does not cause the date/time stamp to appear on images. For printing images with the date on them, refer to page 80, the *Direct Print User Guide* or *Software Starter Guide*.
- For important information, see *Replacing the Date Battery* (p. 105).

Setting the Language

Sets the display language for LCD monitor menus and messages.

1 Turn on the camera (p. 23).

- #### 2 Press the MENU button and select the [MENU] (Set up) menu using ◀ or ▶.



- #### 3 Select [Language] using ▲ or ▼ and press the SET button.



4 Select a language using ▲, ▼, ◀ or ▶ and press the SET button.

- The setting menu will reappear without changing the language setting if you press the **MENU** button instead of the **SET** button.



5 Press the MENU button.



Shortcut Operation

The Language menu can also be displayed in Playback mode by holding down the **SET** button and pressing the **MENU** button. (This function cannot be used while a movie clip is played back, or when a separately sold printer is connected to the camera.)

Basic Functions

Turning the Power On/Off

Shooting Mode

1 Open the lens cover.

- If you further slide it towards "open", the camera will power up. The indicator next to the viewfinder starts blinking green.
- Close the lens cover again to turn the power off.

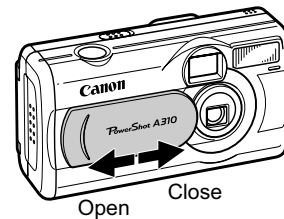

Playback Mode

1 Press the ON button until the image is displayed on the LCD monitor.

- The indicator next to the viewfinder blinks green and the camera powers into Playback mode.

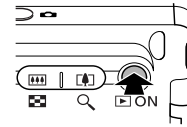

- Press the  ON button again to turn the power off.
- You can print recorded images if you connect the camera to a separately sold printer (see *Direct Print User Guide*).



- You will hear a start-up sound and see the start-up image when the power is turned on. (To change the start-up sound and image, see *Customizing the Camera (My Camera Settings)* p.61, p.93)
- The start-up image does not appear when the LCD monitor is off.

Turning on the camera without the start-up sound and image

Press and hold the **SET** button, then turn on the power.

Power Saving Function

This camera is equipped with a power saving function. Depending on the power saving setting, the camera may power down or the LCD monitor may go off automatically.

●Auto Power Down

[On]

Shooting mode:

Powers down approximately 3 minutes after the last time a camera control is accessed.

Playback mode:

Powers down approximately 5 minutes after the last time a control is accessed on the camera.

Printer Connection mode:

Powers down approximately 5 minutes after the last time a control is accessed on the camera or something is printed on the printer.

When the Auto Power Down Function Activates

Press the ON button again.

[Off]

The power saving function does not activate.

●Display Off

The LCD monitor automatically shuts off approximately 1 minute* after the last time a camera control is accessed.

* This time can be changed (p. 60).

When the Display Off Function Activates

The LCD monitor display turns back on if the shutter button is pressed halfway or when the lens cover is slid open.



- The power saving function is disabled during Auto Play or during a computer connection (p. 74, 84).
- You can turn off the power saving function in the Set up menu (p. 60).

Switching between Shooting/ Playback

You can quickly switch between the Shooting and Playback modes. This is convenient when you wish to shoot again after checking or erasing an image immediately after it is shot.

When shooting mode

1 Press the ON button.

- The camera switches to Playback mode.
- Press the ON button again or press the shutter button halfway to return to the Shooting mode.

When playback mode

1 Open the lens cover.

- The camera switches to Shooting mode.

Using the LCD Monitor

Use the LCD monitor to shoot and review images, for menu operations and playing back images.

Pressing the **DISP.** button cycles the LCD monitor to the next mode.

Shooting Mode

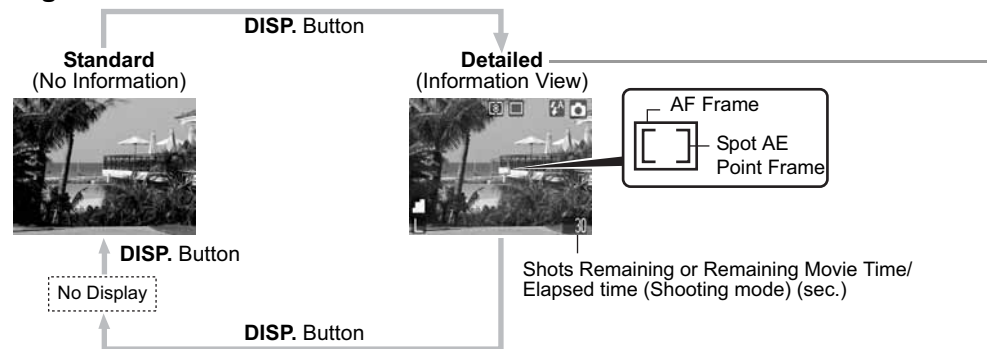

The AF frame changes according to its On/Off setting. (LCD monitor On)

AiAF set to [On] (p. 64)

- Green: Focusing complete (focused AF frame)
- Does not appear: Focusing difficulty

AiAF set to [Off] (p. 64)

- Green: Focusing complete
- Yellow: Focusing difficulty

Shooting Mode		p. 35
Exposure Compensation		p. 65
White Balance		p. 66
ISO Speed		p. 69
Photo Effect		p. 70
Compression		p. 36
Resolution		p. 36
Flash		p. 38
Macro/Infinity		p. 40
Shooting Method		p. 41
Light Metering Mode		p. 65
Movie Recording Mode	● (Red)	p. 45
Digital Zoom Setting	1.3x 1.6x 2.0x 2.5x 3.2x 4.0x 5.1x	p. 31
Camera Shake Warning		p. 29
Low Battery		p. 18

- When a Shooting mode setting is changed, the settings appear on the LCD monitor for about 6 seconds even if the LCD monitor is set to Standard or No display. (The Shooting mode settings may not appear depending on the camera setting.) You can set the flash, Continuous mode, self-timer, Macro/Infinity modes and light metering settings while this information appears on the LCD monitor.
- and the icons in the above appear even when the information view is turned off.
- In addition to the above icons, the AF frame, spot light metering frame, shots remaining or remaining movie time appear as shown on the left.

Playback Mode

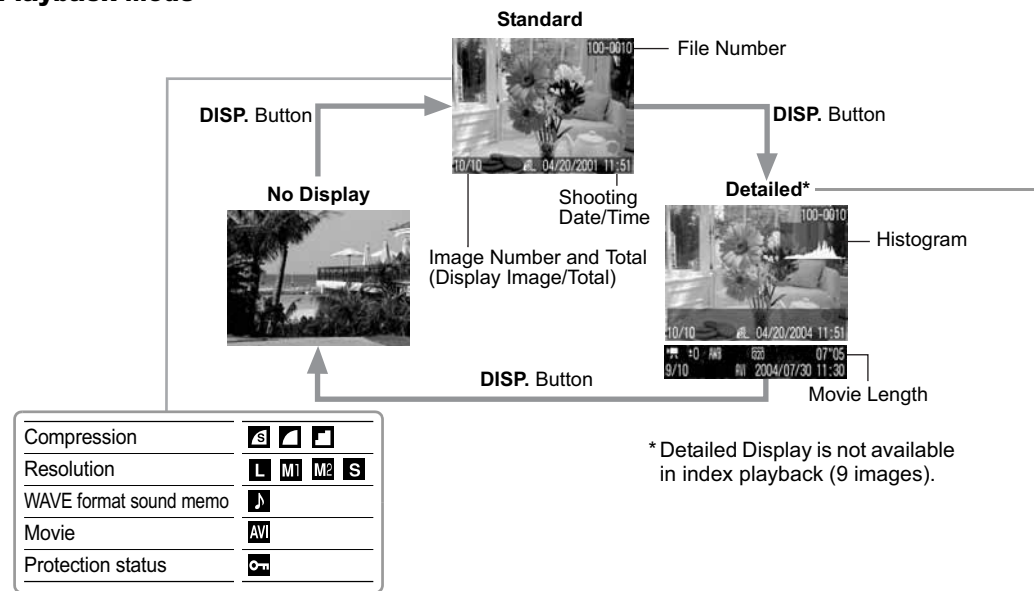

Shooting Mode		p. 35
Exposure Compensation		p. 65
White Balance		p. 66
ISO Speed	ISO 50 100 200 400	p. 69
Photo Effect		p. 70
Resolution (Movie)		p. 36
Flash		p. 38
Light Metering Mode		p. 65
Macro/Infinity		p. 40

In addition to the above, the histogram and recorded movie time are displayed.

The following information may be displayed, depending on the image.

	An audio file other than a wave file, or a file with unrecognized format is attached.
	A JPEG file not supported by "Design Rule for Camera File System" standards.
	RAW file format
	Unrecognizable file formats

The image in the LCD monitor may darken when the monitor is used under sunlight or other strong lighting. This is not a defect.

- The on/off setting of the LCD monitor display mode is memorized when the camera is turned off. When the camera is turned on again it assumes the last mode. However, when the LCD monitor is turned on and the "Change the batteries" message appears, the LCD monitor may not automatically turn on the next time the camera is started.
- Setting the shooting mode to , or turns the LCD monitor on regardless of whether it is set to on or off.
- A slow shutter speed has likely been selected because of insufficient lighting if the upper indicator beside the viewfinder blinks orange after the metering preparations are complete and the camera shake icon displays in the LCD monitor. Set the flash to or , or affix the camera to a tripod to shoot.

- After you take a photo by fully pressing the shutter button, the image displays on the LCD monitor for approximately 3 seconds (or the review duration you set from 3 to 10 seconds). If you press the **SET** button while the image is displayed, it will continue to display (p. 34).
- While a recorded image is displayed on the LCD monitor, you can check the exposure with the graph (See *About the Histogram*). It shows the distribution of the brightness data. If the exposure requires adjustment, set the exposure compensation and re-shoot (Press the **DISP.** button if the histogram and other information is not shown.).
- Please note that image information recorded by this camera may not display correctly on other cameras and image information recorded by other cameras may not display correctly on this camera.

About the Histogram

The histogram is a graph that allows you to judge the brightness of the shot image. The greater the bias toward the left in the graph, the darker the image. The greater the bias toward the right, the brighter the image. If the image is too dark, adjust the exposure compensation to a positive value. Similarly, adjust the exposure compensation to a negative value if the image is too bright (p. 65).

Sample Histograms



Dark image Balanced image Bright image

Shooting – The Basics

See *Functions Available in Each Shooting Mode* (p. 124) at the end of this manual to find out which settings can be changed in which shooting modes.

Auto Mode

In this mode, all you have to do is press the shutter button and let the camera do everything else.

- 1 Set the mode switch to .**
- 2 Aim the camera at the subject.**
- 3 Press the DISP. button to turn the LCD monitor on and use the zoom button to achieve the desired composition (relative subject size in the viewfinder).**

 : The subject will be enlarged.

 : The subject will be reduced.

- Images can be digitally zoomed up to approximately 5.1x.

- The digital zoom can be set to [Off] (p. 57).
- The image will appear grainier as the image is digitally zoomed. However, the actual recorded image is not as coarse as it appears in the LCD monitor.

 Digital zoom is unavailable in some modes (p. 125).

4 Press the shutter button halfway.

- The shutter has a two-stage operation (pressing halfway and pressing fully).

Pressing Halfway

The exposure and focus are automatically set. Indicators show the state of the camera (p. 14).

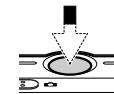

5 Press the shutter button all the way.

Pressing fully

- The shutter sounds once, and the image is shot. The indicator next to the viewfinder blinks green while the image is being recorded to the CF card (p. 14).

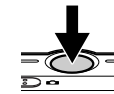



- *Functions Available in Each Shooting Mode* (p. 124).
- With the Review function, you can change the length of time images show on the LCD monitor after shooting, or set it so they do not show at all (p. 34).
- If the orange or yellow indicator blinks while you press halfway, you can still press fully to take the shot.
- Images are first saved into the camera's internal memory before being recorded onto the CF card, allowing the next images to be taken immediately as long as sufficient space is available in the internal memory.
- The beep and shutter sound can be set on/off in the Set up menu (p. 59).
- Even when the shutter sound is set to [■■], [■], [■] (On)] (p. 61), no sound will be heard if [Mute] is set to [On].
- There is no shutter sound in movie mode.
- Shots cannot be taken while the flash is charging.

Shooting with Viewfinder

You can save the power by turning the LCD monitor off and using the viewfinder to shoot.

- 1 Compose the image so that the subject appears in the center of the viewfinder.**

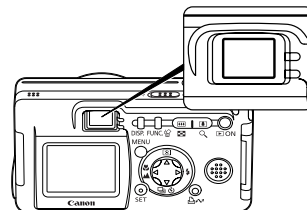

● **Image Seen in Viewfinder vs. Recorded Image**

When shooting an image, a larger range than the one visible in the viewfinder usually gets recorded. You can confirm the actual range that will be recorded in the LCD monitor. In addition, due to the viewfinder's specification, the range visible

in the viewfinder may actually differ from the actual recorded image. The closer the subject is to the lens, the more noticeable the difference will be. In some cases, portions of images shot up close that appear in the viewfinder will not appear in the recorded image. You are recommended to use the LCD monitor during macro photography (p. 40).

● **About the AF Function**

This camera employs AiAF (artificial intelligence autofocus) technology, which uses a broad metering field to calculate the focal distance with high precision. It delivers a crisp focus even when the photographic subject is slightly off-center. The camera can also automatically focus on the center when AiAF is set to [Off].

● **AF-assist Beam**

- The AF-assist beam will sometimes emit when the shutter button is pressed halfway to assist focusing in certain conditions, i.e. dark conditions.

- The AF-assist beam can be turned off (p. 57).
If animals are your subject, turn off the beam when shooting in the dark to avoid startling them. However, please keep in mind the following facts.
 - If the AF-assist beam is turned off, it may become more difficult for the camera to focus.
 - Even if the AF-assist beam is turned off, if the flash is on red-eye reduction auto or is in slow synchro mode, the red-eye reduction lamp may emit.

Reviewing an Image Right After Shooting

After a photo is taken, the image displays on the LCD monitor for 3 seconds. In addition, the image will keep on displaying regardless of the review duration setting if one of the following operations is performed.

- Keeping the shutter button fully pressed
- Pressing the SET button while the image is displayed

Press the shutter button halfway again to stop displaying it.



You can perform the following while images are displayed.

- Display the setting details of the image (p. 28).
- Erasing Images Individually (p. 53)
- Magnifying Images (p. 47) (When pressing the SET button and displaying images)

Changing the Image Display Duration

The length of time images are displayed after a photo has been taken can be changed from between 3 seconds to 10 seconds or turned off.

1 Press the MENU button.

- The [] (Rec.) menu appears.

2 Select [] (Review) using ▲ or ▼.

3 Select a Review setting using ◀ or ▶ and press the MENU button.







- With the [Off] option, the image will not display.
- With the [3 sec.] to [10 sec.] options, the image will appear for the time selected even if you release the shutter button.

- You can continue to display the image as long as the shutter button is fully held pressed regardless of the Review setting.
- Another picture can be taken even while the last is displayed.

Selecting a Shooting Mode



The following modes are available with this camera.

	Auto	The camera automatically makes most of the settings for you.
	Manual	You can manually adjust the exposure, white balance, and other settings before shooting.
	Stitch Assist	For shooting panorama composition images
	Movie	For shooting movies

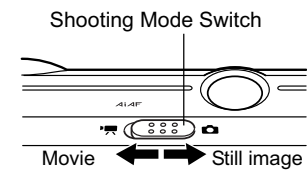
The settings selected for each mode are kept even if the shooting mode is changed. When the power is turned off, the settings are also retained for certain shooting modes, but not for others (p. 124).



Selecting , , or

- 1 Set the shooting mode switch to  and press the SET button.
- 2 Select the shooting mode using  or , and press the SET button.



Selecting

- 1 Set the shooting mode switch to .
 - This will switch to movie mode.



Changing the Resolution and Compression

Shooting Mode    



You can change the resolution and compression (excluding movie) depending on the purpose.

Resolution		Purpose
L (Large)	2048 x 1536 pixels	Large  Small
M1 (Medium1)	1600 x 1200 pixels	
M2 (Medium2)	1024 x 768 pixels	
S (Small)	640 x 480 pixels	
		<ul style="list-style-type: none"> • Print up to A4 size* 210 x 297 mm (8.3 x 11.7 in.) prints • Print up to Letter size* 216 x 279 mm (8.5 x 11 in.) prints • Print postcard size 148 x 100 mm (6 x 4 in.) prints • Print L-size 119 x 89 mm (4.7 x 3.5 in.) prints • Print card size 86 x 54 mm (3.4 x 2.1 in.) prints • Send images as e-mail attachments • Shoot more images

* Paper sizes vary according to region.

Compression			Purpose
	Superfine	High Quality	Shoot higher quality images
	Fine	↑ ↓	Shoot normal quality images
	Normal		Normal

Movies can be shot with the following resolutions.

Resolution	
	640 x 480 pixels
	320 x 240 pixels
	160 x 120 pixels

1 Press the FUNC. button.

2 Select * or * using ▲ or ▼.

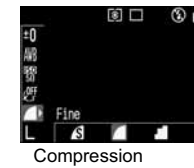

* The current setting is displayed.



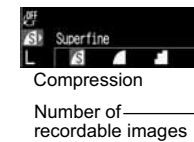



3 Select the compression or resolution you wish to set using ◀ or ▶.







4 Press the FUNC. button.

-  • *Image File Sizes (Estimated)* (p. 115)
-  • *Types of CF cards and resolution* (p. 114)









⚡ Using the Flash

Shooting Mode    

Use the flash according to the guidelines below.

	Auto with Red-eye Reduction	The flash fires automatically as required by the lighting level, and the red-eye reduction lamp fires each time the main flash fires.
	Auto	The flash fires automatically as required by the lighting level.
	Flash On	The flash will fire.
	Flash Off	The flash will not fire.
	Slow Synchro	The flash timing is adjusted to slow shutter speeds. This reduces the chance that the background will be dark when shots are taken at night or in rooms with artificial lighting. The red-eye reduction lamp fires with each shot. Use of a tripod is recommended.

1 Press  (▶ on the omni selector) as necessary to select the desired flash mode.

			 
	○	○	—
	○	○	—
	—	○	△
	○	○	△
	—	○	△

○ : Available △ : Available only for the first image

2 Shoot the image.

- The flash will fire when the indicator next to the viewfinder lights orange (It won't fire if set to ).
- Shooting procedures are the same as for the *Auto Mode* (p. 31).
- Shots cannot be taken while the flash is charging.





- If the flash is used in macro mode, the light may not be controlled correctly. In this case, set a higher ISO sensitivity or use other light sources instead of using the flash.
- When shooting with a high ISO sensitivity and using the flash, there is more of a chance of overexposure the closer you are to the subject.
- Please note that a slow shutter speed will be selected in dark places when the flash is set to off or slow synchro. Be careful to avoid camera shake under these conditions.

Shooting in Mode

Be careful to hold the camera still to avoid camera shake.

Shooting in , or Mode



Fix the camera to a tripod since the shutter speed will be slower than in the  mode. If an image is dark in  mode, reshooting in  mode will make it brighter.









- The flash may take approximately 10 seconds to charge. The LCD monitor, if it is on, will go off after the indicator next to the viewfinder blinks orange while recharging. The LCD monitor will come back on after the indicator lights a steady orange when recharging is completed. Recharging time may vary according to shooting conditions and battery charge levels.
- The flash fires twice. A pre-flash will fire and will be followed by the main flash. The pre-flash is used by the camera to obtain the subject's exposure data so that the main flash can be set to the optimal intensity for the shot.

Red-eye Reduction







- Light reflecting back from eyes can make them appear red when the flash is used in dark areas. Under these conditions, use the Auto with red-eye reduction mode*. For this mode to be effective, the subject must be looking right at the red-eye reduction lamp. Try asking them to look directly at the lamp. Even better results can be obtained by

increasing the lighting in indoor settings or coming closer to the subject.
 *The shutter will not activate for approximately 1 second after the red-eye reduction lamp fires, even when the shutter button is pressed all the way down in order to improve the effect. If you want to have more immediate shutter response, set the flash setting to either ,  or .

Macro/ Infinity Modes

		Shooting Mode     
	Macro	Use this mode when the distance from the lens tip to the subject is 5 to 20 cm (2 to 7.9 in.).
	Infinity	Use this mode to shoot landscapes. Also use this mode for compositions combining both near and distant objects.

1 Press (◀ on the omni selector) to display or .

					
	○	○	△	△	○
	—	○	△	△	○

○ : Available △ : Available only for the first image

- Pressing  (◀ on the omni selector) cancels the macro mode.

2 Shoot the image.





- Shooting procedures are the same as for the *Auto Mode* (p. 31).



 If the flash is used in macro mode, the light may not be controlled correctly. In this case, set a higher ISO sensitivity or use other lightings instead of using the flash.

- 
- Use the LCD monitor for shooting in macro mode. With subjects framed in the viewfinder when in macro mode, part of the image may not appear in the final shot (p. 32).
 - The recordable area at the closest focal distance is approximately 56 x 42 mm (2.2 x 1.7 in.).



Self-timer

Shooting Mode     

1 Press / (▼ on the omni selector) as necessary so that  or  appears on the LCD monitor.

- The image is shot 10 seconds () or 2 seconds () after the shutter button is fully pressed.

2 Shoot the image.

- See page 57 for information on how to select  or .
- When  is selected and the shutter button is pressed fully, the self-timer lamp starts

blinking and the self-timer begins to beep. The blinking gets faster 2 seconds before the shutter releases.

- When  is selected and the shutter button is pressed fully, the self-timer lamp blinks fast from the beginning. The shutter releases in 2 seconds.
- Shooting procedures are the same as for the *Auto Mode* (p. 31).





You can change the self-timer sound by changing the setting in [Selftimer Sound] in the [ (My Camera)] menu (p. 61).

Continuous Mode

Shooting Mode 

Use this mode to shoot successive frames while the shutter button is pressed.

1 Press / (▼ on the omni selector) as necessary so that  appears on the LCD monitor.



2 Press the shutter button halfway to lock the focus.

3 Press the shutter button all the way to shoot.

- Shooting will stop when the shutter button is released.
- The shooting speed is approximately 2.2 frames per second (Large/Fine, LCD monitor off).
(These figures reflect Canon’s testing standard. The actual figures will vary according to the shooting conditions and settings.)

- If internal memory becomes full, intervals between shots may lengthen slightly.
- If you are using the flash, shots are taken more slowly to allow time for the flash to recharge.



Shooting Panoramic Images (Stitch Assist)

Shooting Mode  

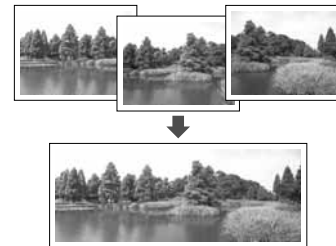
Stitch Assist can be used to shoot overlapping images that can later be merged (stitched) to create one panoramic image on a computer.



There are two stitch assist modes based on the shooting direction as shown in the following.

	Left → Right	Shoots horizontally from left to right.
	Right → Left	Shoots horizontally from right to left.



To merge the images on a computer, use PhotoStitch, one of the supplied programs.

Framing a Subject

The PhotoStitch program detects the overlapping portions of adjoining images and merges them. When shooting, try to include a distinctive item (landmark) in the overlapping portions.



- Compose each frame so that it overlaps 30 to 50 % of the adjoining image. Try to keep the vertical misalignment to within 10 % of the image height.
- Do not include moving items in the overlap.
- Do not try to stitch images that include both distant and close items. Objects may appear warped or doubled up.

- Make the brightness in each image consistent. The final image will appear unnatural if the difference in brightness is too great.
- Pan (swivel) the camera to take successive shots.
- To shoot close-ups, slide the camera over the subject, keeping it parallel to the subject as you move.

Shooting

1 Set the Shooting mode to or .

- See *Selecting a Shooting Mode* (p. 35).

2 Shoot the first image.

- The exposure and white balance settings are set and locked with the first image.

3 Compose and shoot the second image so that it overlaps the first.

- Minor discrepancies in the overlap can be corrected with the software.
- An image can be retaken. Press ◀ or ▶ to return to that frame.



Sequence

4 Use the same procedures to shoot the remaining frames.

- A maximum of 26 images can be recorded either horizontally or vertically.

5 Press the SET button after the last shot.







- A custom white balance setting (p. 68) cannot be set in [Sequence]/[Sequence] mode. To use a custom white balance setting, first set it in another shooting mode.
- The settings in place for the first image are locked in and cannot be changed for subsequent shots.



See page 124 for settings that can be changed in this mode.

Movie Mode

Shooting Mode 

Use this mode to shoot movies. The resolution can be set to [ (640 x 480)], [ (320 x 240)], or [ (160 x 120)] (p. 36).



1 Set the shooting mode switch to .

- The LCD monitor turns on and displays the maximum recording time (in seconds).

2 Press the shutter button all the way.

- Shooting and sound recording starts simultaneously.
- During the shooting a red circle appears in the upper right of the LCD monitor.

3 Press the shutter button all the way to stop recording the movie.

- The maximum length of a movie clip (15 frames/sec) is  : approx. 30 seconds*,  : approx. 3 minutes,  : approx. 3 minutes.

* Using the following CF cards:

- Supplied FC-32MH CF Card
- Separately sold Canon FC-256MH or FC-512MSH CF Card (not sold in some regions)

These times may vary with the subject and shooting conditions. Recording will automatically stop when the maximum is reached or when the CF card runs out of free capacity.



- You are recommended to use a CF card that has been formatted in your camera to shoot movies (p. 18). The card supplied with the camera may be used without further formatting.
- The recording time may not display properly during shooting or filming may stop unexpectedly with the following types of CF cards.
 - Slow recording cards
 - Cards formatted on a different camera or a computer
 - Cards which have had images recorded and erased repeatedly
 Although recording time may not display properly during shooting, the movie will

be recorded correctly on the CF card. Recording time will display properly if you format the CF card in this camera (excluding slow recording CF cards).

- Be careful not to touch the microphone while shooting.
- The AE, AF, white balance and zoom settings are set and locked to the settings of the first frame.
- The indicator next to the viewfinder blinks green after a shot. You cannot shoot again until it stops blinking.



- See page 124 for settings that can be changed in this mode.
- Sound is recorded monaurally.
- There is no shutter sound in movie mode.
- QuickTime 3.0 or higher is required to playback movie files (AVI/Motion JPEG) on a computer. (QuickTime (for Windows) is bundled on the supplied Digital Camera Solution Disk. On the Macintosh platform, QuickTime 3.0 or later is generally bundled with the Mac OS 8.5 or later operating system.)

Playback – The Basics

Displaying Images Individually (Single Image Playback)





You can view the recorded images on the LCD monitor.

1 Press the ON button.

- The last image shot is displayed (Single Image Playback).



2 Press or to switch the displayed image.

- Use  to move to the previous image and  to move to the next. Holding  or  moves more rapidly between images, but the images will not appear as clearly.



You may not be able to play back images that have been shot with another camera or edited on a computer with other software applications.









- Press the **DISP.** button to show the data for the displayed image (p. 28).
- Press the  button to quickly delete the displayed image (p. 53).

Magnifying Images

Images can be magnified up to approximately 10 times during single image playback.

1 Press the button.

- Pressing the  button while holding the **SET** button magnifies the image approx. 2.5 times, approx. 5 times and 10 times in order.
- Press , ,  or  to change the display position vertically and horizontally.
- To return to normal-size display, press the  button several times.



Approximate position



Movie frames and index playback images cannot be magnified.



You can magnify an image while it is displayed on the LCD monitor in Shooting mode immediately after the image is shot (p. 34).

Viewing Images in Sets of Nine (Index Playback)

Up to 9 images can be viewed at once in index playback.

1 Press the  ON button.

2 Press the  button.

- 9 images appear at a time (Index Playback).

3 Press **▲**, **▼**, **◀** or **▶** to select the image.

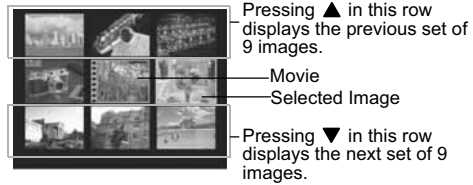

4 Press the  button.

- Index playback cancels and the display reverts to single image playback.

 Press the **DISP.** button to show the data for the displayed image (p. 28).

Jumping between Images

The display can be advanced or set back 9 images when in index playback.

1 Press the button in index playback (p. 48).

- The jump bar appears.

2 Change the image selection.

- Jump 9 images back or forward using ◀ or ▶.
- Hold the **SET** button and press ◀ or ▶ to jump to the first or last image.



Jump Bar

3 Press the button.

- The jump bar disappears and the camera returns to index playback.
- If you press the  button once more, the camera returns to single image playback.

Viewing/Editing Movies

Viewing Movies

You can play back the images shot in  mode.

1 Press the button.

- Movies cannot be viewed in index playback mode.

2 Press ◀ or ▶ to select a movie and press the **SET** button.

- A movie displays with the  icon on it.
- The movie playback panel appears.

3 Select (Play) using ◀ or ▶ and press the **SET** button.

- The movie images and sound will play.
- You can adjust the volume using ▲ or ▼.



Movie Playback Panel

Volume





- When a movie has finished playing, it will display the last frame. If the **SET** button is pressed in this state, the camera will revert to the movie playback panel. If the **SET** button is pressed again, the movie will start playing from the first frame.

Pausing and Resuming Play

- Press the **SET** button to pause the movie. Press it again to resume.

Fast Forwarding/Rewinding

- Select one of the following operations using ◀ or ▶ and press the **SET** button.

	(Exit):	Return to single image playback
	(First Frame):	Display the first frame
	(Previous Frame):	Return to the previous frame (Rewinds if the SET button is held down)
	(Next Frame):	Proceed to the next frame (Fast forwards if the SET button is held down)
	(Last Frame):	Display the last frame



You may experience frame dropping and audio breakup when playing back a movie on a computer with insufficient system resources.



- The volume at which movies play back can also be adjusted in the Set up menu (p. 59).
- If you set [Mute] to [On] in the Set up menu (p. 58), no sound is reproduced. However, you can resume the sound and adjust the volume during movie playback using ▲ or ▼.

Editing Movies

You can delete unwanted portions from the first or second half of the movie clip.

1 Select the movie you wish to edit, and press the **SET** button.

- See *Viewing Movies* (p. 49).



2 Select  (Edit) using **◀** or **▶** and press the **SET** button.

- The movie editing panel and the movie editing bar will appear.

3 Select the editing method using **▲** or **▼**.



Movie Editing Panel Movie Editing Bar

-  (Cut beginning): Deletes frames in the first half of the movie
-  (Cut end): Deletes frames in the second half of the movie
-  (Exit): Reverts to the movie playback panel

4 Select the editing position using **◀** or **▶**.



5 Select  (Play) using **▲** or **▼** and press the **SET** button.

- The temporarily edited movie will start playing.
- The movie will stop if you press the **SET** button while it is playing.

6 Select  (Save) using **▲** or **▼**, and press the **SET** button.



- When  is selected, the edited movie is not saved and the camera reverts to the movie playback panel.

7 Select **[Overwrite]** or **[New File]** using **◀** or **▶** and press the **SET** button.



- **[Overwrite]**: Saves the edited movie under the same file name as the original movie. The original data is deleted.
- **[New File]**: Saves the edited movie under a new file name. The original data is not deleted.
- When there is not enough space left on the CF card, only the overwrite function is available. If this happens, ▲ appears on the counter of the movie editing bar.



- Protected movies cannot be edited.
- It may take approx. 3 minutes to save an edited movie. In case the battery runs out during that period, the saving process may not be able to be completed. To prevent this, it is recommended to use new AA size alkaline batteries or fully charged AA-size NiMH batteries (sold separately), or the AC Adapter Kit ACK 800 (sold separately) (p. 109).





Movies with an original length of 1 second or more can be edited in 1-frame units.

Erasing

 Remember that erased images cannot be recovered. Be careful to avoid accidental erasures.

Erasing Single Images

1 Press the  ON button.

2 Press  or  to select the image you want to erase and press the  button.





- A confirmation screen appears.

3 Press  or  to select [Erase] and press the SET button.

- Select [Cancel] instead of [Erase] and press the SET button if you decide you do not want to erase the image.

 Protected images cannot be erased with the erase function (p. 75).

Erasing All Images

1 In the  (Play) Menu, select  (Erase all) and press the SET button.

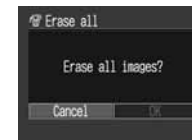

- A confirmation screen appears.

2 Press  or  to select [OK] and press the SET button.

- Select [Cancel] instead of [OK] and press the SET button if you decide you do not want to erase the images.

-  Protected images cannot be erased with the erase function (p. 75).
- All the images recorded in the CF card will be erased if you select [Erase all].
 - To erase the images and all other data recorded in the CF card, see *Formatting a CF Card* (p. 18).

Shooting – Advanced Functions

Selecting Menus and Settings

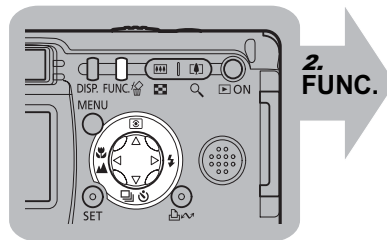

Selecting Settings by Pressing the FUNC. Button (Shooting Mode Only)





- 1 Open the lens cover to turn the power on.
- 2 Press the FUNC. button.
- 3 Select a FUNC. menu option using ▲ or ▼ and select setting contents using ◀ or ▶.
- 4 Press the FUNC. button.
- 5 Shoot the image.

3. Press ▲ or ▼ to select a menu item, then press ◀ or ▶ to select the settings you wish to set.

Exposure Compensation (±0)(p. 65) Compression () (p. 36)



White Balance () (p. 66)



ISO Speed () (p. 69)









Photo Effect () (p. 70)



Resolution () (p. 36)



Resolution (Movie) () (p. 37)



Items in () show default settings.

4. FUNC. → 5. Shoot the image.

Selecting Settings by Pressing the MENU Button

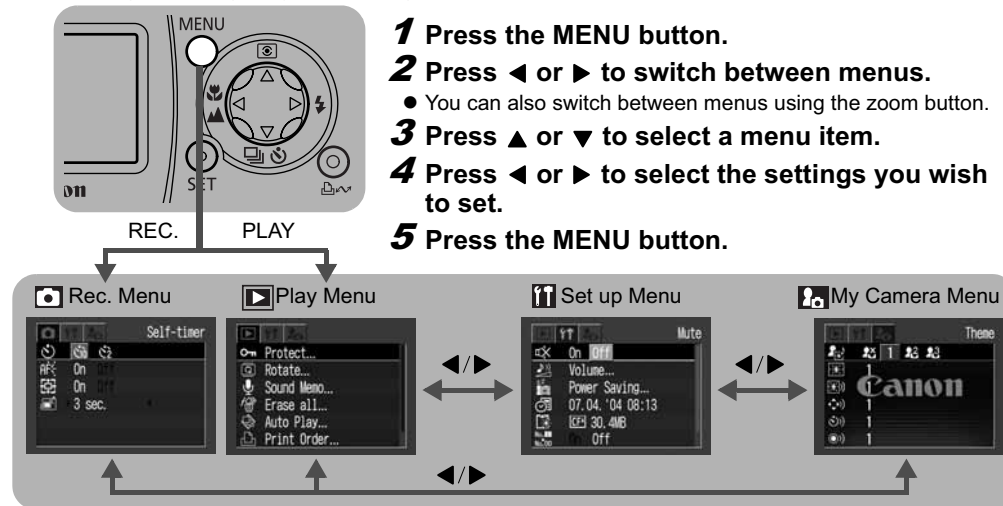

1 Press the MENU button.

2 Press ◀ or ▶ to switch between menus.

- You can also switch between menus using the zoom button.



3 Press ▲ or ▼ to select a menu item.

4 Press ◀ or ▶ to select the settings you wish to set.

5 Press the MENU button.

- For items with [...] next to them, push the **SET** button and carry out the settings from the next displayed menu. Once the settings are complete, press the **SET** button again and confirm these settings.
- In Shooting mode, you can also close the menu by pressing the shutter button halfway.









- Some menu items may not be available for selection according to the shooting mode (p. 124).
- You can apply a desired image and sound to  and  in the My Camera menu. For details, see the *Registering My Camera Settings* (p. 94) or the *Software Starter Guide*.
- The default of all the settings changed by the menu and button operations except for Shooting mode, [Date/Time] and [Language] can be restored all at once (p. 62).







Menu Settings and Default Settings

Rec. Menu

*Default Setting



Menu Items	Setting Content	Reference Page
 AiAF	Sets the AiAF to on (the camera automatically selects the AF frame when taking a picture) or off (AF frame is set to the center frame). • On* / Off	64
 Self-timer	Sets the duration before the self-timer releases the shutter once the shutter button is pressed.  (10 seconds)*  (2 seconds)	41
 AF-assist Beam	Sets the output of the AF-assist beam according to shooting conditions when using the autofocus. • On* / Off	33
 Digital Zoom	Turns the digital zoom on or off. • On* / Off	31
 Review	Sets the duration images display on the LCD monitor after the shutter button is released. • Off / 3* – 10 sec.	34





Play Menu

Menu Items	Setting Content	Reference Page
 Protect	Protects images from accidental erasure.	75
 Rotate	Rotates images 90 or 270 degrees clockwise in the display.	72
 Sound Memo	Attaches a sound memo to images.	73
 Erase all	Erases all images from a CF card (excluding protected images).	53
 Auto Play	Plays images automatically one after the other.	74
 Print Order	Sets which images and how many copies will be printed on a direct print function compatible printer (CP series) or at a photo lab service.	78
 Transfer Order	Sets the images that will be downloaded to a computer.	82







Set up Menu

*Default Setting

Menu Items	Setting Content	Reference Page
 Mute	Set [On] to mute the start-up sound, operation sound, self-timer sound and shutter sound all at once. For details, see <i>How the Mute setting in the [ (Set up)] menu and each sound setting in the [ (My Camera)] menu are related (p. 61).</i> • On / Off * Note that the error warning signal beeps even when the Mute setting is [On].	-

	Adjusts the volume of the start-up sound, operation sound, self-timer sound, shutter sound, or playback sound. The volume cannot be adjusted if [Mute] is set to [On]. • (Off) / (1) / (2)* / (3) / (4) / (5)	-
Volume	 Start-up Vol. Adjusts the Start-up Sound volume when the camera powers up.	23
	 Operation Vol. Adjusts the Operation Sound volume when any button except the shutter button is operated.	-
	 Self-timer Vol. Adjusts the volume of the Self-timer Sound heard from 2 seconds prior to the shot until the actual shot.	41
	 Shutter Volume Adjusts the Shutter Sound volume when the shutter button is pressed all the way. There is no shutter sound in Movie mode.	31
	 Playback Vol. Adjusts the sound volume when a sound memo or movie is played.	49, 73







Shooting – Advanced Functions

	The Auto Power Down and Display Off settings can be set by pressing the SET button.	-
 Power Saving	<p> Auto Power Down Sets whether or not the camera automatically powers down after a specified period of time elapses without camera operation. • On* / Off</p>	24
	<p> Display Off Specifies a period of time before the LCD monitor turns off when no camera operation is performed. • 10 sec. • 1 min.* • 20 sec. • 2 min. • 30 sec. • 3 min.</p>	24
 Date/Time	Sets the date, time and date format.	20
 Format	Formats (initializes) a CF card.	18
 File No. Reset	Sets how file numbers are assigned to images. • On / Off*	92
 Language	<p>Sets the language used in the menus and messages on the LCD monitor.</p> <ul style="list-style-type: none"> • English* • Italiano • Deutsch • Norsk • Français • Svenska • Nederlands • Español • Dansk • Chinese • Suomi • Japanese <p>You can change the language during image playback by holding the SET button and pressing the MENU button.</p>	21

Customizing the Camera (My Camera Settings)

You can select the theme, start-up image and sound, shutter sound, operation sound and self-timer sound used on this camera. These are called My Camera settings. You can also customize the **[1]** and **[2]** options for each item with images from the CF card and newly recorded sounds or by using the supplied software. See the *Software Starter Guide* for details.

*Default Setting

Item/Menu Screen	Setting Content	Reference Page
 Theme	Selects a common theme for the start-up image, startup sound, shutter sound, operation sound, and self-timer sound.* ¹	93
 Start-up Image	Sets the start-up image when you turn on the camera.* ¹	93
 Start-up Sound	Sets the start-up sound when you turn on the camera.* ¹	93
 Operation Sound	Sets the sound when any button other than the shutter button is operated.* ¹	93
 Selftimer Sound	Sets the sound informing you that the photo will be taken in 2 seconds.* ¹	93
 Shutter Sound	Sets the shutter sound when you depress the shutter button. There is no shutter sound in Movie mode.* ¹	93
My camera menu settings content	[3] (Off) / [1] * / [2] / [3]	93

*¹ How the [Mute] setting in the **[1]** (Set up) menu and each sound setting in the **[2]** (My Camera) menu are related

To turn off the start-up sound, the shutter sound, operation sound, and self-timer sound all at once, set [Mute] in the **[1]**, **[2]**, **[3]** (Set up) menu to [On]. This setting overrides each setting for those sounds. Note that the error warning signal beeps even when the [Mute] setting is [On].

Resetting the Settings to Default

You can reset all of the menu and button operation settings to default.

1 Turn on the camera.

- Can be performed from Shooting or Playback mode.

2 Press the MENU button for longer than 5 seconds.

- The message "Reset settings to default?" appears on the LCD monitor.

3 Press ◀ or ▶ to select [OK], and press the SET button.

- The screen on the right appears while resetting. The normal screen resumes when resetting is complete.
- To cancel resetting, select [Cancel] instead of [OK].

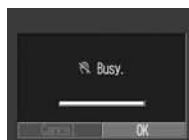

- The following settings do not reset to default.
 - Shooting mode, Date/Time and Language in the [M] (Set up) menu (p. 60)
 - The custom white balance (p. 68)
 - Newly registered My Camera settings (p. 93)
- When the camera is connected to a computer or a printer, this operation does not work.

Shooting Problem Subjects for the Autofocus

Shooting Mode 

The following types of subjects may not be suited to autofocus photography. Use the focus lock in these situations.

- Subjects with extremely low contrast to the surroundings
- Subjects mixing close and far objects
- Subjects with extremely bright objects at the center of the composition
- Subjects that are moving quickly
- Subjects with horizontal stripes

1 Aim the camera so that a subject at the same focal distance as the main subject is centered in the viewfinder or in the AF frame displayed on the LCD monitor.

2 Press and hold the shutter button halfway, and wait until the camera beeps twice.

3 Re-aim the camera direction to compose the shot as desired and press the shutter button all the way.





- When using focus lock, the focus will lock on the subject in the center AF frame if you set **AI/AF** to [Off] in the [ (Rec.)] menu.
- When shooting through glass, get as close as possible to avoid reflection off the glass.

Switching between Focus Settings

Shooting Mode 

You can change the autofocus frame (AF frame) selection method. The AF frame will appear when the LCD monitor is turned on (p. 26).

	<p>On (Auto Selection)</p>	<p>The camera automatically selects an AF frame from five AF frames to focus on according to the shooting conditions.</p>
	<p>Off (Center Selection)</p>	<p>Focuses on the center AF frame. This helps you to make sure that the focus is exactly where you want it.</p>

 indicates the AF frame which appears on the monitor.

1 In the [ (Rec.)] menu, select **AiAF** (AiAF).

- See *Selecting Menus and Settings* (p. 55).

2 Press **◀** or **▶** to select **[On]** or **[Off]**.











3 Press the **MENU** button.

- Press the shutter button instead of the **MENU** button to shoot an image with the set AF frame.

 The center AF frame mode is used when the digital zoom is activated.

Switching between Light Metering Modes

Shooting Mode 		
	Evaluative Metering	Appropriate for standard shooting conditions, including backlit scenes. The camera divides images into several zones for light metering. It evaluates the complex lighting conditions, such as the position of the subject, the brightness, the direct light, and the backlighting, and adjusts the settings to the correct exposure for the main subject.
	Center-Weighted Averaging	Averages the light metered from the entire frame, but gives greater weight to the subject matter at the center.
	Spot AE Point	Meters the area within the spot AE point at the center of the LCD monitor. Use this mode when the subject is backlit or surrounded by strong light.

- 1 Press  (▲ on the omni selector) as necessary to display either , , or , and shoot image.

Adjusting the Exposure

If you are shooting against a bright background or strong backlight, you may need to correct the exposure so that the subject doesn't come out too dark.

- 1 Select * (+/- (Exp.)) from the FUNC. menu.

- See *Selecting Menus and Settings* (p. 54).

* The current setting is displayed.



- 2 Press ◀ or ▶ to adjust the compensation.

- The settings can be adjusted in 1/3 stops in the range -2 to +2.



- You can check the results of the compensation by viewing the image on the LCD monitor when it is on.
- You can shoot the image right after selecting settings by pressing the shutter button. The menu displays again after the shot, allowing you to change the settings easily.





3 Press the FUNC. button.



- To cancel the exposure compensation, return the setting to 0 using ◀ or ▶.

Adjusting the Tone (White Balance)

Shooting Mode    

When the white balance is set to match the light source, the camera can reproduce colors more accurately.

	Auto	The camera sets the white balance automatically according to shooting conditions.
	Day Light	Use when shooting outdoors in sunlight on a clear day.
	Cloudy	Use when shooting outdoors and the sunlight is not enough such as under cloudy skies, in shade or at dusk.
	Tungsten	For shooting under tungsten and bulb-type 3-wavelength fluorescent lighting.
	Fluorescent	For shooting under warm-white, cool-white or warm-white (3-wavelength) fluorescent lighting.

	Fluorescent H	For shooting under daylight fluorescent, or daylight fluorescent-type (3-wavelength) fluorescent lighting.
	Custom	For setting a custom value with a white sheet of paper, etc., to obtain the optimal white balance for the conditions.

1 Select * (Auto) from the FUNC. menu.

- See *Selecting Menus and Settings* (p. 54).

* The current settings is displayed.



2 Press ◀ or ▶ to select white balance.

- See page 68 regarding the  custom setting.
- When the LCD monitor is on, you can check the setting on the display.



- A shot can be taken immediately by pressing the shutter button. The menu will reappear after the shot, allowing you to adjust the setting.

3 Press the FUNC. button.

 The white balance cannot be adjusted when the photo effect is set to  (sepia) or  (B/W).

Setting a Custom White Balance

You can set a custom white balance to obtain optimal settings for your particular shooting conditions by having the camera evaluate a subject such as a white piece of paper or cloth, or a photo-quality gray card. In the following three situations the white balance may not be correctly adjusted in the **AWB** (Auto) mode. Always shoot after reading and setting the white balance data in the **Custom** mode.

- Shooting at close distances (Macro mode)
- Shooting monotone subjects (such as the sky, sea, forest, and so on)
- Shooting under special light sources such as mercury lamps

1 Select **AWB*** (Auto) from the FUNC. menu.

- See *Selecting Menus and Settings* (p. 54).

* The current settings is displayed.

2 Select **Custom** using **◀** or **▶**.

3 Aim the camera at a piece of white paper or cloth, or gray card and press the SET button.





- Aim the camera so that the white paper or cloth completely fills the frame at the center of the LCD monitor or the entire optical viewfinder before pressing the **SET** button. The camera reads the white balance data when you press the **SET** button.
- You can shoot right after setting the white balance. The menu displays again after the shot, allowing you to change the settings easily.

4 Press the FUNC. button.





- To set and use a custom white balance setting, it is advisable to select the **CM** shooting mode and set the exposure compensation to zero (± 0). The correct white balance may not be obtained

when the exposure is incorrect (image is completely black or white).

- Since the white balance data cannot be read in  and  modes, preset the white balance in another shooting mode.
- Shoot with the same settings as when reading the white balance data. If the settings differ, the optimal white balance may not be set. Especially the following should not be changed.

Flash

- Setting the flash to on or off is recommended. If the flash fires when reading the white balance data with the flash set to  or , make sure that you also use the flash when you shoot.

ISO Speed

- The custom white balance setting is not canceled even if settings are reset to default settings (p. 62).

Changing the ISO Speed

Shooting Mode 

Raise the ISO speed when you wish to reduce camera shake, when turning the flash off for use in dark conditions, or when a fast shutter speed is required.

1 Select * (ISO Speed) from the FUNC. menu.

- See *Selecting Menus and Settings* (p. 54).

* The current setting is displayed.

2 Press or to select the ISO speed.

- A shot can be taken immediately by pressing the shutter button. The menu will reappear after the shot, allowing you to adjust the setting.



3 Press the FUNC. button.









- Higher ISO speeds increase the image noise. To take clean images, use as low an ISO speed as possible.
- The AUTO setting selects the optimal speed. It will automatically raise the speed when the light from the flash is insufficient to illuminate the subject matter.

Changing the Photo Effect

Shooting Mode    

You can shoot with different photo effects.

	Effect Off	Records normally with this setting.
	Vivid	Emphasizes the contrast and color saturation to record in bold colors.
	Neutral	Tones down the contrast and color saturation to record neutral hues.
	Low Sharpening	Records subjects with softened outlines.
	Sepia	Records images in sepia tones.
	B/W	Records images in black and white.

1 Select * (Effect OFF) from the FUNC. menu.

- See *Selecting Menus and Settings* (p. 54).

* The current settings is displayed.

2 Select the photo effect using ◀ or ▶.

- If the LCD monitor is on, you can check the photo effect by viewing the image on the LCD monitor.
- A shot can be taken immediately by pressing the shutter button. The menu will reappear after the shot, allowing you to adjust the setting.



3 Press the FUNC. button.

Playback – Advanced Functions

Rotating Images in the Display

You can rotate an image by 90° or 270° clockwise in the LCD monitor.



0° (Original)

90°

270°

1 In the [ (Play)] Menu, select  (Rotate).

- See *Selecting Menus and Settings* (p. 55).

2 Press ◀ or ▶ to select the image to be rotated and press the SET button.

- Press the SET button to rotate the image 90°, 270° and back to original orientation.

3 Press the MENU button.

- The Play menu appears again. Press the MENU button again to close the menu.





- Movie images cannot be rotated.
- If an image has been rotated in the camera before being loaded onto a computer, the particular software in use will determine whether or not the rotation settings are retained.





Rotated images can be magnified (p. 47).

Attaching Sound Memos to Images

In Playback mode (including single image playback, index playback, and magnified playback), you can attach sound memos (up to 60 seconds) to an image. The sound data are saved in WAVE format.

1 Select  (Sound Memo) from the  (Play) menu.

- See *Selecting Menus and Settings* (p. 55).
-  appears.

2 Select the image to which you wish to attach the sound memo using  or , and press the SET button.







Sound Memo Panel

- The Sound Memo panel appears.

3 Select  using  or  and press the SET button.

- The recording starts and the elapsed time is displayed. Speak towards the microphone of the camera.
- To stop recording, press the SET button. To restart recording press the SET button again.
- You can add as many sound memos as you like until their total reaches 60 seconds.

Playing the Sound Memos

- Select  in step 3. The  icon is displayed on images with sound memos.
- To stop playback, press the SET button. To resume playback, press the SET button again. You can adjust the volume using  or .

Erasing the Sound Memos

- Select  in step 3.

Exiting the Sound Memos Settings

- Press the MENU button.



- You cannot attach sound memos to movies.
- You cannot record or play back sound memos for images that already have an incompatible sound file attached. If you attempt to record or play such images the "Incompatible WAVE format" message will display. Incompatible sound files can be deleted with this camera.
- Sound memos for protected images cannot be erased (p. 75).



- You can also adjust the volume of the sound memo in the Set up menu (p. 59).
- If you set [Mute] to [On] in the Set up menu (p. 58), no sound is reproduced. However, you can resume the sound and adjust the volume during movie playback using ▲ or ▼.

Auto Play

Use this feature to automatically play back all of the images in the CF card (Auto Play). The LCD monitor displays each image for approximately 3 seconds.

1 In the [▶] (Play) menu, select [Auto Play].

- See *Selecting Menus and Settings* (p. 55).
- Once you have selected it, Auto Play starts.
- As with the single image playback mode, using ◀ or ▶ during auto play will advance through the images more rapidly.

Pausing and Resuming Auto Play

- You can pause Auto Play at any time by pressing the **SET** button. You can then restart it by pressing the **SET** button again.

Stopping Auto Play

- To stop Auto Play, press the **MENU** button.



- The display interval may vary for some images.
- Movie images play for the length of time that they were recorded.
- The power saving function (p. 24) is disabled during Auto Play.

Protecting Images

Use the protect feature to protect important images from accidental erasure.

1 In the [ (Play)] menu, select  (Protect).

- See *Selecting Menus and Settings* (p. 55).

2 Select an image you want to protect using ◀ or ▶ and press the SET button.



Protected Icon

- The  icon appears on protected images.
- To release the protection, press the **SET** button again.
- Image can be selected in both single image playback and index playback modes (p. 47, 48).

3 Press the MENU button.

- The camera returns to the menu screen. Press the **MENU** button again to exit the menu screen.



Please note that formatting (initializing) a CF card erases all data, including protected images (p. 18) and other file types. Please check the contents of a CF card before formatting it.

Various Functions

About Printing

Images shot with this camera can be printed using one of the following methods.

- Connecting the camera to a direct print compatible printer*¹ with a single cable and pressing the  button on the camera.
- Selecting images and specifying the number of print copies (DPOF*² print settings) with the camera before sending the images (CF card) to a photo developing center that supports DPOF.

*¹This camera complies with the *PictBridge* standard, which allows you to print with non-Canon *PictBridge* compliant printers as well.

*²Digital Print Order Format

This manual explains the DPOF print settings. For information on how to print images, refer to the *Direct Print User Guide* supplied with the camera. Also, refer to your printer's manual.

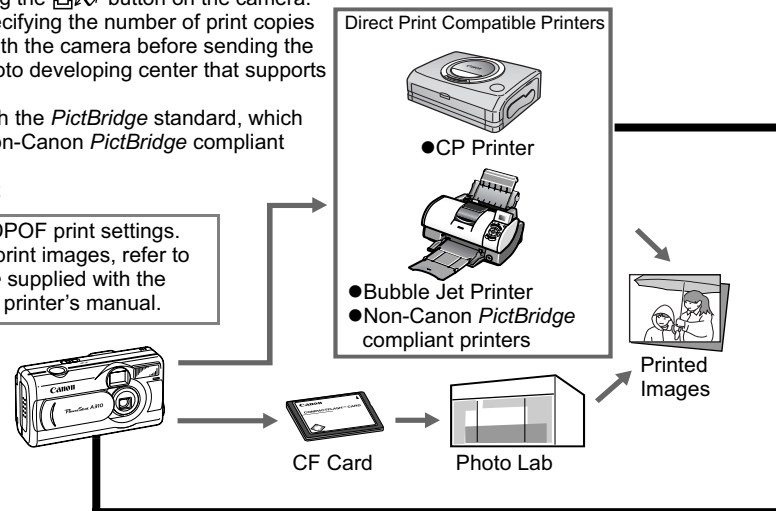

Please refer to the *System Map* supplied with your camera for direct print compatible printer information (CP series or Bubble Jet printers).

Direct Print Compatible Printing

- Connect the camera to the printer
- Set various print settings (except DPOF print settings)
- Print



For printing instructions, see the *Direct Print User Guide* (separate from this guide).

DPOF Print Settings

- Select the image you want to print (p. 78)
- Select how many copies you want (p. 78)
- Select the print style (p. 80)
 - Standard/Index/Both
 - Date On/Off
 - File Numbers On/Off

For printing instructions, see the *Direct Print User Guide* (separate from this guide).

DPOF Transfer Settings

- Select the images you want to download to a computer (p. 82)

DPOF Print Settings



You can select images on a CF card for printing and specify the number of print copies in advance using the camera. This is extremely convenient for sending the images to a photo developing service that supports DPOF or for printing on a direct print function compatible printer.

Refer to the *Direct Print User Guide* for instructions on how to select print settings from the printer.





- The  mark may appear on images that have had print marks set by another DPOF compliant camera. These settings will be overwritten by any print marks set by your camera.
- The output of some digital printers or photo lab services may not reflect the specified print settings.
- Movies cannot be printed.

Selecting Images for Printing

1 In the  (Play) menu, select  (Print Order) and press the SET button.



- See *Selecting Menus and Settings* (p. 55).

2 Select [Order] using  or  and press the SET button.



3 Select images for printing.

Single Images

- When the print type (p. 80) is set to [Standard] or [Both], select an image using . You can set the number of copies (up to 99) to be printed using  or .



- When the print type (p. 80) is set to [Index], select an image using ◀ or ▶ and mark or remove marks from images using ▲ or ▼. A check mark appears on the marked image.



- Press [] to switch to index playback. You can use the same procedures to select images in index playback (3 images).

All the Images on a CF Card

- Press [] to switch to index playback (3 images).
- You can set one copy of each image to print by pressing the **SET** button, then selecting [Mark all] using ▲ or ▼, and pressing the **SET** button again.
- When the print type is set to [Standard] or [Both], the setting for the number of print copies can be changed for each image.



When [Index] is selected, the print settings can be deleted. For the instructions on changing settings, please reread Step 3 from the beginning.

- You can cancel all the settings by selecting [Clear all].

4 Press the MENU button.



- The setting will be complete and the Print Order menu will reappear.





- Images are printed in order from oldest to newest by the shooting date.
- A maximum of 998 images can be set.
- When [Print Type] is set to [Both], the number of copies can be set. When it is set to [Index], the number of copies cannot be set (only one copy will be printed).
- Print settings can also be assigned to images with the bundled software programs (ZoomBrowser EX or ImageBrowser) on a computer.



Setting the Print Style

You can set up the print style as follows.

	<input checked="" type="checkbox"/> Standard	Print one image per sheet.
	<input type="checkbox"/> Index	Print index prints (multiple reduced-size images per page).
	<input type="checkbox"/>  Both	Print selected images both in standard and index format.
<input checked="" type="checkbox"/> Date		Include the date on the print.
 File No.		Include the file number on the print.

1 In the [] (Play) menu, select  (Print Order) and press the SET button.

- See *Selecting Menus and Settings* (p. 55).

2 Select [Set up] using  or  and press the SET button.



3 Select  (Print Type), (Date) or  (File No.) using  or .

4 Select a setting using  or .



 **Print Type**
Select [Standard],[Index] or [Both].



Date
Select [On] or [Off].



 **File No.**
Select [On] or [Off].

5 Press the MENU button.

- The set up menu will close and the Print Order menu will reappear.

- If you have chosen [Index] as the print type, you cannot set [Date] and [File No.] to [On] at the same time.
- With CP printers, if you have chosen [Both] as the print type, you can set both [Date] and [File No.] to [On], however, only the file number is printed for the index print.

 The date prints as the date and time in the format specified in the Set Date/Time menu (p. 20).

Resetting the Print Settings

The Reset feature clears all print selections, and resets Print Type to [Standard], Date to [On], and File No. to [Off].

1 In the [▶] (Play) menu, select [Print Order] and press the SET button.

- See *Selecting Menus and Settings* (p. 55).

2 Press ◀ or ▶ to select [Reset] and press the SET button.





3 Press ◀ or ▶ to select [OK] and press the SET button.



- Select [Cancel] and press the SET button to cancel the reset.

Image Transmission Settings (DPOF Transfer Order)



You can use the camera to specify settings for images before downloading to a computer. Refer to the *Software Starter Guide* for instructions on how to transfer images to your computer. You cannot use this function to transfer several images at once to a Mac OS X computers. The settings used on the camera comply with the Digital Print Order Format (DPOF) standards.

 The  mark may appear on images that have had transfer marks set by another DPOF compliant camera. These settings will be overwritten by any marks set by your camera.

Selecting Images for Transferring

1 In the  [Play] menu, select  (Transfer Order) and press the SET button.

- See *Selecting Menus and Settings* (p. 55).





2 Press  or  to select [Order] and press the SET button.

- You can remove all the transfer marks at once by selecting [Reset].









3 Select images for transferring.

For setting images one by one

- Press  or  to select the image and mark or remove checkmarks from images using  or . The check marks are displayed when set.
- The above method can be used even if you press  to switch to index playback (3-images display).



For setting all images on the CF card

- Switch to index playback (a set of 3 images) by pressing .
- Press the **SET** button, select [Mark all] using  or  and press the **SET** button again to mark all the images. (If you select [Clear all] instead of [Mark all], you can remove marks from all the images.)
- You can select images using  or  and change the settings using  or  after [Mark all] or [Clear all] has been selected.



4 Press the MENU button.

- The selection mode will turn off and the Transfer Order menu will reappear.



- Images are transferred in order from oldest to newest by the shooting date.
- A maximum of 998 images can be marked.

Downloading Images to a Computer

The following methods can be used to download images recorded by the camera to a computer. Some methods are not applicable to all operating systems.

● Downloading via a Camera to Computer Connection



- With this method, you download images using computer commands after you have installed the appropriate software.
 - ➔ See *Connecting the Camera to a Computer* (p. 84) and the separate *Software Starter Guide*.



- With this method, you download images using camera button operations after you have installed the appropriate software (the computer settings only need to be adjusted for the first download).
 - ➔ See *Connecting the Camera to a Computer* (p. 84) and *Downloading Images by Direct Transfer* (p. 88).

Windows XP	Mac OS X
---------------	-------------

● With this method, you download images using computer commands without installing any software.
 ➔ See *Connecting the Camera to a Computer* (below) ("Software Installation Not Required"), and *Connecting the Camera to the Computer to Download Images without Installing Software* (p. 90).

●Downloading Directly from a CF Card

With this method, you download images using a card adapter or card reader.
 ➔ See *Downloading Directly from a CF Card* (p. 91).

Connecting the Camera to a Computer

Computer System Requirements

●Windows

OS	Windows 98 (Including Second Edition) Windows Me Windows 2000 Windows XP (Home Edition, Professional)
----	--

Computer Model	The above OS should be pre-installed on computers with built-in USB ports.
CPU	Windows 98/Windows Me/Windows 2000: Pentium 150 MHz or higher processor Windows XP: Pentium 300 MHz or higher processor For all of the above OS: Pentium 500 MHz or higher processor is recommended (for editing movies)
RAM	Windows 98/Windows Me/Windows 2000: 64 MB or more Windows XP: 128 MB or more For all of the above OS: 128 MB or more is recommended (for editing movies)
Interface	USB
Free Hard Disk Space	●Canon Utilities - ZoomBrowser EX: 200 MB or more (Including the PhotoRecord printing program) - PhotoStitch: 40 MB or more ●Canon Camera TWAIN Driver: 25 MB or more ●Canon Camera WIA Driver: 25 MB or more

Display	800 x 600 pixels/High Color (16bit) or better is required 1,024 x 768 pixels or better is recommended
---------	--

●Macintosh

OS	Mac OS 9.0 - 9.2, Mac OS X (v10.1/v10.2)
Computer Model	The above OS should be pre-installed on computers with built-in USB ports.
CPU	PowerPC
RAM	Mac OS 9.0 - 9.2: 64MB or more of application memory Mac OS X (v10.1/v10.2): 128MB or more
Interface	USB
Free Hard Disk Space	● Canon Utilities - ImageBrowser: 120MB or more - PhotoStitch: 30MB or more
Display	800 x 600 pixels/ 32,000 colors or better is required 1,024 x 768 pixels or better is recommended

IMPORTANT

You must install the software and driver bundled on the supplied Canon Digital Camera Solution Disk onto your computer before connecting the camera to a computer.



The camera will not operate correctly if you connect it to your computer before installing the driver and software. If this happens, please refer to the *Troubleshooting* section of the *Software Starter Guide*.



- You do not need to turn off the camera or computer power when making a USB connection.
- Please refer to your computer's manual for information regarding the location of the USB port.
- You are recommended to use new AA size batteries, fully charged AA size NiMH batteries or AC Adapter Kit ACK800 (sold separately) to power the camera when connecting to a computer (p. 106, 109).

- All procedures performed with a connection to a USB 2.0 compliant board are not guaranteed.

1 Install the driver and the software applications bundled on the Canon Digital Camera Solution Disk (first time only).

- Please see the *Software Starter Guide* for the installation procedures.

2 Use the supplied interface cable to connect the computer's USB port to the camera's DIGITAL terminal.

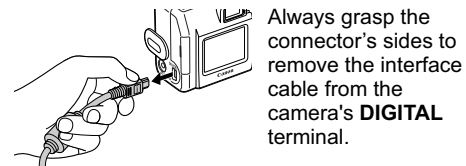
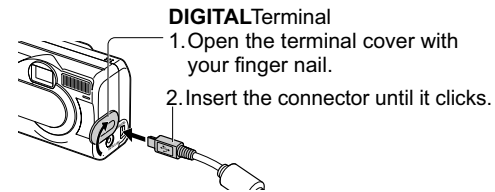
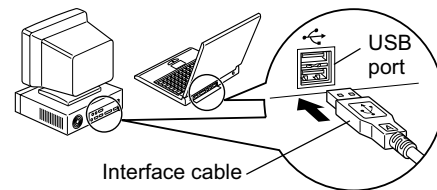

3 Press the  ON button.

- **Windows**
→ Proceed to steps 4 and 5 below.
- **Macintosh**
→ Refer to the *Software Starter Guide* and download images.

4 Select [Canon CameraWindow] in the events dialog that appears on the computer and click [OK] (first time only).



! If the events dialog fails to appear, click the [Start] menu, followed by [Programs] or [All Programs], [Canon Utilities], [CameraWindows], and [CameraWindow - Set Auto-Launch].

5 Click [Set] in the [CameraWindow - Set Auto-Launch] window (first time only).

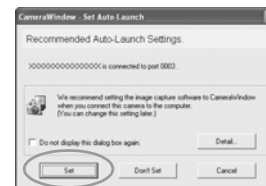





• The Download Image window will display.



- **Using the software and computer to download images:**
→ See the *Software Starter Guide*.
- **Using the Camera to Download Images (Direct Transfer Function):**
→ See *Downloading Images by Direct Transfer* (below).

Downloading Images by Direct Transfer

Use this method to download images using camera operations.
Install the supplied software and adjust the computer settings before using this method for the first time (p. 86).

	All Images	Transfers and saves all images to the computer.
	New Images	Transfers and saves to the computer only the images that have not been previously transferred.
	DPOF Trans. Images	Transfers and saves to the computer only the images with DPOF Transfer Order settings (p. 82).
	Select & Transfer	Transfers and saves single images to the computer as you view and select them.

	Wallpaper	Transfers and saves single images to the computer as you view and select them. The transferred images display on the computer desktop.
---	------------------	--





1 Confirm that the Direct Transfer menu is displayed on the camera's LCD monitor.

- The  button will light blue.
- Press the **MENU** button if the Direct Transfer menu fails to appear.



Direct Transfer Menu



All Images/New Images/DPOF Trans. Images

2 Use **▲** or **▼** to select ,  or  and press the  button.



- To cancel the transfer, press the **SET** button.
- The images will download and the Direct Transfer menu will reappear.

Select & Transfer/Wallpaper

2 Use **▲** or **▼** to select  or  and press the  button (or **SET** button).



3 Use **◀** or **▶** to select images to download and press the  button (or **SET** button).

- The images will download. The  button will blink blue while downloading is in progress.

4 Press the **MENU** button.

- The Direct Transfer menu will reappear.

 Only JPEG format images can be downloaded as wallpaper for the computer.

 The option selected with the  button is retained even when the camera's power is turned off. The previous setting will be in effect the next time the Direct Transfer menu is displayed. The image selection screen will appear directly when the [Select & Transfer] or the [Wallpaper] option was last selected.

Connecting the Camera to the Computer to Download Images without Installing Software

If you are using Windows XP or Mac OS X (v10.1 or v10.2), you can use the software distributed with these operating systems to download images (JPEG format only) without installing the software bundled on the Canon Digital Camera Solution Disk. This is useful for downloading images to a computer in which the software is not installed. However, please note that there are certain limitations to downloading images with this method. For more details, please refer to the *For Windows® XP and Mac OS X Users* leaflet.

1 Use the supplied interface cable to connect the computer's USB port to the camera's DIGITAL terminal.

- See steps 2 and 3 of p. 86.

2 Follow the onscreen instructions to proceed with downloading.

Downloading Directly from a CF card

- 1 Eject the CF card from the camera and insert it into a CF card reader connected to the computer.**

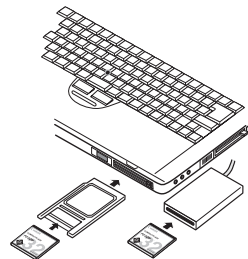

- If you are using a PC card reader or a PC card slot, first place the CF card into a PC card adapter (sold separately) and then insert the loaded adapter into the slot.
- Refer to your PC card adapter's or PC card reader's manual for information regarding the connection between the computer and card adapter or card reader.

- 2 Double-click the icon of the drive with the CF card.**

- Depending on the operating system, a window opens automatically.

- 3 Copy images from the card into a folder of your choice on the hard disk.**

- The images are stored in the [xxxCANON] folders located in the [DCIM] folder (where xxx is a three-digit number from 100 to 998 (p. 92)).

Resetting the File Number

Select the set up method for the file number.

On	The camera resets the file number to 100-0001 each time you insert a new (unused) CF card. If you insert a card that already contains some images, numbering resumes from the next available number.
Off	The camera remembers the last file number, and starts numbering from the next number when you insert a new CF card.

1 In the **[M] (Set up)** menu, select **[No.] (File No. Reset)**.

- See *Selecting Menus and Settings* (p. 55).



2 Press **◀** or **▶** to select **[On]** or **[Off]**.

3 Press the **MENU** button.



- Setting the File No. Reset to **[Off]** is useful for avoiding file name duplication when images are downloaded to a computer.

About File and Folder Numbers

- Images are assigned file numbers from 0001 to 9900, and folders are assigned folder numbers from 100 to 998 (Folder numbers cannot contain 99 in the last two digits).

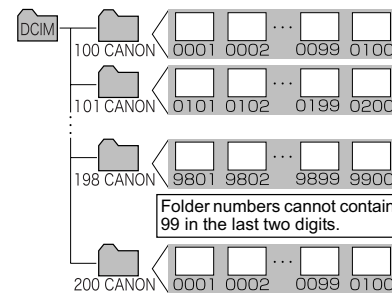

Folder File Capacity

- Each folder usually contains up to 100 images. However, since images shot in Continuous Shooting or Stitch Assist mode are always saved into the same folder, a folder may contain more than 100 images. The number of images may also exceed 100 if a folder contains images copied from a computer or images shot with other cameras. Please note, however, that the images in folders containing 2001 or more images cannot be played back in this camera.

Customizing the Camera (My Camera Settings)

My Camera allows you to customize the start-up image and start-up, shutter, operation and self-timer sounds. Each menu item has three choices.

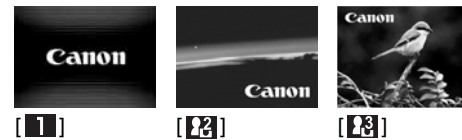
Ex: Start-up image

As default settings, My Camera setting [2] has a science fiction theme and My Camera setting [3] has an animal theme.

Changing My Camera Settings**1 Press the MENU button.**

- The [(Rec.)] or [(Play)] menu appears.

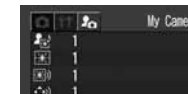
**2 Select [(My Camera)] using ◀ or ▶ and select a menu item using ▲ or ▼.**

3 Select the contents you wish to set using ◀ or ▶.



4 Press the MENU button.

- Pressing the button closes the menu and makes the settings take effect.
- In Shooting mode, the menu can be closed by pressing the shutter button halfway.



- If you select [Theme] in Step 3, you can select a consistent theme for each of the My Camera settings.
- If [Mute] in the [M] (Set up) menu is set to [On], the beep does not sound even if each sound item such as [Start-up Sound], [Operation Sound], [Selftimer Sound] or [Shutter Sound] in the [L] (My Camera) menu is set to [1], [2], [3] (On) (p. 61). The error warning signal beeps even if [Mute] is set to [On].

Registering My Camera Settings

Images recorded onto the CF card and newly recorded sounds can be added as My Camera settings to the [P] and [R] menu items. You can also use the supplied software to upload your computer's images and sounds to the camera.

The following menu items can be saved to the camera.

- Start-up Image
- Start-up Sound
- Operation Sound
- Self-timer Sound
- Shutter Sound

Registering the CF Card Images and Sounds

1 Press the ▶ON button.

- The camera powers into Playback mode.

2 Press the MENU button.

- The [ (Play)] menu appears.



3 Select [ (My Camera)] using ◀ or ▶ and select the menu item you wish to register using ▲ or ▼.



4 Select  or  using ◀ or ▶.

-   appears.



5 Press the DISP. button.

- An image appears.



Start-up Image: Go to step **6a, 7a**
 Start-up Sound, Shutter Sound, Operation Sound,
 and Self-Timer Sound: Go to step **6b, 7b**

6a Select the image you wish to register using ◀ or ▶.

7a Press the SET button.



6b Select  (Record) using ◀ or ▶ and press the SET button.



- Recording starts.
- Recording stops when the time is exceeded.
 Start-up Sound: 1 second
 Operation Sound: 0.3 seconds
 Self-timer Sound: 2 seconds
 Shutter Sound: 0.3 seconds

7b Select  (Register) using ◀ or ▶.

8 Select OK using ◀ or ▶ and press the SET button.



- Sounds recorded using the Sound Memo function (p. 73) and movies cannot be registered as My Camera settings.
- When you register new My Camera settings, the previously registered settings are erased.

File Format of My Camera Settings





My Camera settings should conform to the below file formats. However, CF card images shot with this camera can be registered as My Camera settings regardless of the below formats.

- **Start-up Image**
 - Recording Format JPEG (baseline JPEG)
 - Sampling Rate 4:2:0 or 4:2:2
 - Image Size 320 x 240 pixels
 - File Capacity 20 KB or less

● **Start-up, Operation, Self-timer and Shutter Sounds**

- Recording Format WAVE (monaural)
- Quantization Bits 8 bit
- Sampling Frequency 11.025 kHz or 8.000 kHz

• **Recording Time**

	11.025 kHz	8.000 kHz
 Start-up Sound	1.0 sec. or less	1.3 sec. or less
 Operation Sound	0.3 sec. or less	0.4 sec. or less
 Self-timer Sound	2.0 sec. or less	2.0 sec. or less
 Shutter Sound	0.3 sec. or less	0.4 sec. or less

Any file formats other than those described above cannot be used with this camera.

As example of this function is to record "Say Cheese", the self-timer sound so the camera will play back this sound 2 seconds before the photo is taken. You could also record cheerful music to bring out the natural smiles of your subjects, or so

they can strike a pose fitting the music. In these ways you can customize your camera by creating and adding new My Camera settings.

See the supplied *Software Starter Guide* for more information on creating and adding to the My Camera Settings files.

List of Messages

The following table explains each of the messages that may appear on the LCD monitor.

- For messages which may appear when a printer is connected, refer to the *Direct Print User Guide*.

Busy...	The camera is recording image data to the CF card. The playback mode is running.
No memory card	You attempted to shoot or play back with no CF card installed.
Cannot record!	You attempted to shoot with no CF card installed.
Memory card error!	There is something wrong with the CF card.
Memory card full	CF card is too full to accommodate more images or print settings.
Naming error!	The file could not be created because there is a file with the same name as the directory that the camera is attempting to create, or the highest possible file number has already been reached. In the Rec. Menu, set the File Reset option to [On]. Save all the images you wish to retain onto a computer, then reformat the CF card. Please note that formatting will erase all the existing images and other data.
Change the batteries	Battery charge is insufficient to operate the camera. Replace both batteries at the same time with new AA-size alkaline batteries (p. 15) or fully recharged Canon NiMH batteries.
No image	No images recorded on CF card.
Image too large	You attempted to play back an image larger than 4064×3048 pixels or with a large file size.
Incompatible JPEG format	You attempted to play back an incompatible JPEG file.
Corrupted data	You attempted to play back an image with corrupted data.

RAW	You attempted to play back an image recorded in the RAW format.
Unidentified Image	You attempted to play back an image that was recorded in a special format (proprietary format used by the camera of another manufacturer) or a movie that was taken with another camera.
Cannot magnify!	You attempted to magnify an image which was photographed with another camera, recorded in a different format, or edited on a computer or a movie clip.
Cannot rotate!	You attempted to rotate an image which was photographed with another camera, recorded in a different format, or edited on a computer or a movie clip.
Incompatible WAVE format	A sound memo cannot be added to this image since the format of the existing sound memo is incorrect.
Cannot register this image!	You attempted to register an image recorded with another camera or a movie clip as a start-up image.
Protected!	You attempted to erase protected image or movie clip.
Too many marks!	Too many images have been marked for printing or transferring. Cannot process any more.
Cannot mark image	You attempted to set the print settings for a non-JPEG file.
Exx	Camera malfunctioned. Turn off the power and turn on again, then re-shoot or play back. If the same message recurs frequently, the camera may be damaged. Note down the error number [xx] and take the camera to a Customer Support Help Desk. If this message appears immediately after you have taken a shot, the camera may not have shot the image. Switch to the Playback mode and check whether the image was actually recorded.

Troubleshooting

Problem	Cause	Solution
The camera will not operate.	The camera is turned off.	<ul style="list-style-type: none"> ● Turn the power on. (See <i>Turning the Power ON/OFF</i> (p. 23))
	The CF card slot/battery cover is open.	<ul style="list-style-type: none"> ● Be sure the cover is closed securely.
	Batteries are loaded in the wrong direction.	<ul style="list-style-type: none"> ● Reload the batteries in the correct direction.
	Batteries are depleted.	<ul style="list-style-type: none"> ● Replace with unused alkaline (two AA-size batteries) or fully recharged Canon AA-size NiMH batteries. ● Use a household power source.
	Batteries are not the right type.	<ul style="list-style-type: none"> ● Use only new AA-size alkaline batteries or Canon AA-size NiMH batteries. (For the information about alkaline batteries, see <i>Proper Battery Handling</i> (p. 16).)
	Batteries are not making good electrical contact with the camera.	<ul style="list-style-type: none"> ● Wipe the battery terminals with a clean dry cloth.
The camera will not shoot.	Camera is in Playback mode.	<ul style="list-style-type: none"> ● Change to a Shooting mode.
	The flash is charging.	<ul style="list-style-type: none"> ● Wait until the flash charges. You can press the shutter button when the indicator lights orange steadily.
	The CF card is full.	<ul style="list-style-type: none"> ● Insert a new CF card. ● Download images to your computer, then erase them from the card to free up more space.

Problem	Cause	Solution
The camera will not shoot.	The CF card is not formatted correctly.	<ul style="list-style-type: none"> ● Format the CF card. (p. 18). ● The card may be defective (its logical may be corrupted). Contact Canon Customer Help Desk.
Cannot play back	You attempted to play back images shot with another camera or images edited with a computer.	<ul style="list-style-type: none"> ● Computer images that cannot be played back will playback if they are added to the camera using the bundled software program ZoomBrowser EX or ImageBrowser. See the <i>ZoomBrowser EX/ImageBrowser User Guide</i> (PDF).
	File name was changed with a computer or file location was changed.	<ul style="list-style-type: none"> ● Set the file name or location to the file format/structure of the camera (See <i>About File and Folder Numbers</i> (p. 92)).
The batteries are consumed quickly.	Batteries are not the right type.	<ul style="list-style-type: none"> ● Use only new AA-size alkaline batteries or Canon AA-size NiMH batteries. (For the information about alkaline batteries, see <i>Proper Battery Handling</i> (p. 16).)
	Battery capacity drops due to low ambient temperatures.	<ul style="list-style-type: none"> ● If shooting in a cold area, keep the batteries warm (by placing them in an inner pocket, etc.) until ready to use them.
	Battery terminals are dirty.	<ul style="list-style-type: none"> ● Wipe them well with a dry cloth before use.
	The batteries have not been used for over a year.	<ul style="list-style-type: none"> ● Performance should return to normal after several charging cycles.
	The batteries have lost their effectiveness.	<ul style="list-style-type: none"> ● Replace both batteries with new ones.

Troubleshooting

Problem	Cause	Solution
Batteries do not charge with a separately sold battery charger.	Batteries were placed in the charger in the wrong direction.	<ul style="list-style-type: none"> ● Put batteries back into the charger in the correct direction.
	Poor electrical contact, between batteries and the charger.	<ul style="list-style-type: none"> ● Be sure to set batteries firmly into the charger. ● Be sure that the power cable is firmly connected to the charger, and is firmly plugged in to the power outlet.
	Battery terminals are dirty.	<ul style="list-style-type: none"> ● Wipe them well with a dry cloth before charging.
	The batteries have lost their effectiveness.	<ul style="list-style-type: none"> ● Replace both batteries with new ones.
Shots are blurry or unfocused.	The camera was moving when you took the shot.	<ul style="list-style-type: none"> ● Hold the camera steady when shooting.
	Autofocus function hampered by obstruction to AF-assist beam.	<ul style="list-style-type: none"> ● Be careful not to block the AF-assist beam flash part with a finger or other object.
	The AF-assist beam is set to [Off].	<ul style="list-style-type: none"> ● Turn the [AF-assist beam] setting [On] (p. 57).
	The subject was outside the range over which the camera can focus.	<ul style="list-style-type: none"> ● Ensure that there is at least 20 cm (7.9 in.) between the camera lens and subject. ● Use the macro mode to shoot close-ups between 5 to 20 cm (2 to 7.9 in.) from the lens. ● When shooting distant subjects, set the camera to infinity mode.
	The subject is difficult to focus on.	<ul style="list-style-type: none"> ● Use the Focus Lock when shooting (See <i>Using the Focus Lock</i> (p. 63)).

Problem	Cause	Solution
The subject comes out underexposed (too dark).	Insufficient light for shooting.	<ul style="list-style-type: none"> ● Set the flash on.
	The subject is darker than the surroundings.	<ul style="list-style-type: none"> ● Set exposure compensation to a positive value or use the spot metering function.
	The subject is beyond the range of the flash.	<ul style="list-style-type: none"> ● When flash is used, the distance between lens and subject should not exceed 2 m (6.7 ft.). ● Raise the ISO speed (See <i>Changing the ISO Speed</i> (p. 69)).
The subject comes out overexposed (too bright).	The subject is too close to the flash.	<ul style="list-style-type: none"> ● When flash is used, the distance between lens and subject should be no less than 20 cm (7.9 in.).
	The subject is brighter than the surroundings.	<ul style="list-style-type: none"> ● Set exposure compensation to a negative value or use the spot metering function.
	Light is shining or reflecting into the camera.	<ul style="list-style-type: none"> ● Adjust the camera angle.
	The flash mode is set so that the flash always fires.	<ul style="list-style-type: none"> ● Set the flash to any other mode except on.
A vertical bar of light (red, purple) appears on the LCD monitor.	The subject is too bright.	<ul style="list-style-type: none"> ● This is normal occurrence in devices containing CCDs and does not constitute a malfunction. (This red bar of light will not be recorded when shooting still photos, but it will be recorded when shooting movies.)
White dots or white asterisks appear on the image.	Light from the flash has reflected off dust particles or insects in the air.	<ul style="list-style-type: none"> ● This is a phenomenon that occurs with digital cameras and does not constitute a malfunction.

Troubleshooting

Problem	Cause	Solution
The flash doesn't fire.	The flash mode is set to off.	<ul style="list-style-type: none"> ● Set the flash mode to any other mode except Off.
Reading images from CF card is slow.	CF card was formatted in another device.	<ul style="list-style-type: none"> ● Use a CF card formatted in your camera. (See <i>Formatting a CF Card</i> (p. 18).)
Recording images to CF card takes a long time.		

Appendix

Replacing the Date Battery

If the LCD monitor displays the Date/Time menu when you turn on the camera, this means that the date battery has run down and the clock has stopped running. Please purchase a replacement battery (battery type CR2016) and install it as follows. (The date battery is preinstalled at the factory and may therefore expire earlier than its rated lifespan after the camera has been purchased.)

 Be particularly careful to keep the date batteries out of the reach of children. Seek medical assistance immediately if a child swallows a battery since corrosive battery fluids could damage the stomach or intestinal wall.

1 Be sure that the camera is turned off.

2 Pull out the date battery holder in the direction of the arrow.

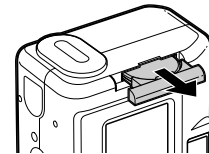

3 Shift the date battery slightly in the direction of the arrow ① and pull out the battery in the direction as shown with arrow ②.

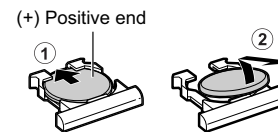

4 Insert the new date battery into the holder with the (+) side facing up.

5 Replace the date battery holder back into its original position.

6 Set the date and time when the **Date/Time** menu is displayed on the LCD monitor (p. 20).



The LCD monitor also displays the Date/Time menu the very first time you turn on the camera. This is normal, and you don't need to replace the date battery.

Using the Power Kits (Sold Separately)

Using Rechargeable Batteries

(Battery and Charger Kit CBK4-200)

Included are the battery charger and four rechargeable AA-size NiMH (nickel metal hydride) batteries. Charge the batteries as shown below.

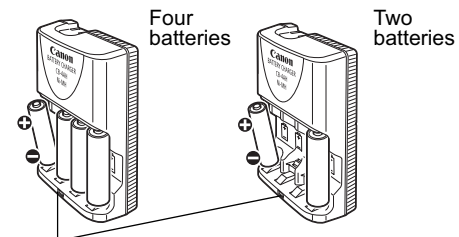

Charge Indicator

* Two batteries can be charged instead of four.

The indicator blinks while charging, then remains lit when charging is finished.



Four batteries are supplied with the Battery and Charger Kit CBK4-200, however, only two batteries are used for this camera.



- This charger can be used only to charge Canon AA-size NiMH batteries NB-2AH. Please do not attempt to charge NB-2AH batteries in any other type of charger.
 - Never mix new batteries together with batteries that have been used in other devices.
 - When recharging batteries from the camera, always recharge both of them at the same time.
 - Do not mix batteries with different purchase dates or different charge states.
 - Do not attempt to recharge fully charged batteries, as doing so may reduce or impair battery performance. Also, do not charge batteries for more than 24 consecutive hours.
 - Do not recharge batteries in enclosed areas that tend to retain heat.
 - Repeatedly recharging batteries before they become fully depleted may cause batteries to lose capacity. Do not recharge the batteries until the LCD monitor displays the "Change the batteries" message.
- Wipe the battery terminals well with a dry cloth in the following situations, as the terminals may be soiled with oil from one's skin or other dirt:
 - If the battery usage time has considerably diminished.
 - If the number of recordable images has considerably diminished.
 - When charging the batteries (insert and remove the batteries two or three times before charging)
 - When charging completes in a matter of a few minutes (the battery charger indicator remains lit)
 - You may not be able to fully charge the batteries due to their specifications right after purchase or after long periods of non-use. If this happens, use the batteries until their charge is depleted before charging them again. After doing this several times, battery performance will be restored.

- Since storing a fully charged battery for long periods of time (about one year) can shorten its lifecycle or affect performance, you are recommended to use the battery in the camera until it is completely discharged and to store it at normal temperature (23 °C/73 °F or less). If you do not use the battery for long periods of time, charge it fully and discharge it fully in the camera at least once a year before returning it to storage.
- If battery usage time is considerably low despite their terminals' being wiped and the battery charger's indicator remaining lit, it is possible that the batteries have reached the end of their lifespan. Switch to different, unused batteries. If you are purchasing new batteries, look for Canon AA-size NiMH batteries.
- Leaving batteries in the camera or charger may damage it causing battery leakage. Remove batteries from the camera or charger and store in a dry cool location when not in use.



- It takes approximately 110 minutes when two batteries are loaded one at each end of the charger and 250 minutes with four for the charger to fully recharge them (as determined by testing at Canon facilities). Please do not charge batteries in areas where the temperature is outside the range of 0 to 35 °C (32 to 104 °F).
- Charging time varies according to ambient temperature and to the batteries' initial charge state.
- The battery charger may emit noise while charging. This is not a malfunction.
- You can also use Battery/Charger Kit CBK100. For Battery/Charger Kit CBK100, use Canon AA-size NiMH batteries NB-1AH.

Using the AC Adapter Kit ACK800

Use of the separately sold AC Adapter Kit ACK800 is recommended when using the camera continuously for prolonged periods of time and when connecting to a computer.

 Be sure that the camera is turned off before connecting or disconnecting the compact power adapter.

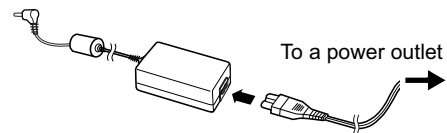
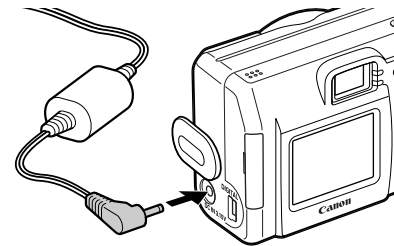
1 Connect the power cord to the compact power adapter, and then plug the other end into the power outlet.**2 Open the terminal cover, and connect the adapter's DC plug into the camera's DC IN terminal.**

- Please unplug the adapter from the power outlet when you have finished using the camera.

 Please do not attempt to use any AC adapter other than AC Adapter Kit ACK800 with your camera. Use of a different adapter may result in damage to the camera or to the adapter kit.

Camera Care and Maintenance

Use the following procedures to clean the camera body, lens, viewfinder, LCD monitor and other parts.

Camera Body	Wipe the camera body with a soft cloth or eyeglass lens wiper.
Lens	First use a lens blower brush to remove dust and dirt, then remove any remaining dirt wiping the lens lightly with a soft cloth. <ul style="list-style-type: none">● Never use synthetic cleaners on the camera body or lens. If dirt remains, contact the closest Canon Customer Support Help Desk as listed on the separate Canon Customer Support leaflet.
LCD Monitor, Viewfinder	Use a lens blower brush to remove dust and dirt. If necessary gently wipe the viewfinder and LCD monitor with a soft cloth or an eyeglass lens wiper to remove stubborn dirt. <ul style="list-style-type: none">● Never rub or press forcefully on the LCD monitor. These actions may damage it or lead to other problems.



Never use water, paint thinner, benzene, or detergents to clean the camera, as these may cause damage or deformation.

Specifications

All data is based on Canon's standard testing methods. Subject to change without notice.

Camera Effective Pixels	Approx. 3.2 million
Image Sensor	1/2.7-inch CCD (Total number of pixels: Approx. 3.3 million)
Lens	5.0 mm (35 mm film equivalent: 33 mm), f/3.6
Digital Zoom	Up to approx. 5.1x
Optical Viewfinder	Inverted Galilean viewfinder
LCD Monitor	1.5-inch, low-temperature polycrystalline silicon TFT color LCD, approx. 78,000 pixels
AF System	TTL autofocus Focusing frame: 5-point AiAF/1-point AF Focus lock available
Shooting Distance (from the front of the lens)	Normal AF: 20 cm (7.9 in.) – infinity. Macro AF: 5 – 20 cm (2.0 – 7.9 in.)
Shutter	Mechanical shutter + electronic shutter
Shutter Speeds	1 – 1/2000 sec. ● 1 – 1/6 sec. shutter speeds are available in manual or stitch assist mode if the flash is off and in slow synchro mode. Slow shutter speeds of 1/6 sec. or slower operate with noise reduction.
Light Metering System	Evaluative, Center-weighted average or Spot
Exposure Control System	Program AE
Exposure Compensation	± 2 stops in 1/3-stop increments
Sensitivity	Auto, ISO 50/100/200/400 equivalent
White Balance	TTL auto, pre-set (available settings: Daylight, Cloudy, Tungsten, Fluorescent, Fluorescent H) or Custom

Specifications													
Flash	Auto, Red-eye Reduction, On, Off, Slow Synchro												
Flash Range	20 cm – 2.0 m (7.9 in. – 6.7 ft.) (When sensitivity is set to ISO Auto)												
Shooting Modes	Auto/Manual/Stitch assist/Movie												
Continuous Shooting	Approx. 2.2 shots/sec. (Large/Fine mode, LCD monitor off)												
Self-timer	Activates shutter after an approx. 10-sec./approx. 2-sec. delay												
PC-controlled Shooting	Available (USB connection only. Exclusive software program is included in the camera kit.)												
Recording Media	CompactFlash™ (CF) card (Type I)												
File Format	Design rule for camera file system and DPOF compliant												
Image Recording Format	Still images : JPEG (Exif 2.2)* ¹ Movies : AVI (Image data : Motion JPEG; Audio data : WAVE (monaural))												
Compression	Superfine, Fine, Normal												
Number of Recording Pixels	<table border="0"> <tr> <td>Still Images</td> <td>Large : 2048 x 1536 pixels</td> <td>Medium 1: 1600 x 1200 pixels</td> </tr> <tr> <td></td> <td>Medium 2: 1024 x 768 pixels</td> <td>Small : 640 x 480 pixels</td> </tr> <tr> <td>Movies</td> <td>640 x 480 pixels (Approx. 30 sec.)*²</td> <td>320 x 240 pixels (Approx. 3 min.)</td> </tr> <tr> <td></td> <td>160 x 120 pixels (Approx. 3 min.)</td> <td>15 frames/sec.</td> </tr> </table> <p>The data in parentheses refer to the maximum movie length per shooting.</p>	Still Images	Large : 2048 x 1536 pixels	Medium 1: 1600 x 1200 pixels		Medium 2: 1024 x 768 pixels	Small : 640 x 480 pixels	Movies	640 x 480 pixels (Approx. 30 sec.)* ²	320 x 240 pixels (Approx. 3 min.)		160 x 120 pixels (Approx. 3 min.)	15 frames/sec.
Still Images	Large : 2048 x 1536 pixels	Medium 1: 1600 x 1200 pixels											
	Medium 2: 1024 x 768 pixels	Small : 640 x 480 pixels											
Movies	640 x 480 pixels (Approx. 30 sec.)* ²	320 x 240 pixels (Approx. 3 min.)											
	160 x 120 pixels (Approx. 3 min.)	15 frames/sec.											
Playback Modes	Single (histogram displayable), Index (9 thumbnail images), Magnified (approx. 10x (max.) in LCD monitor), Auto play or Sound memos (up to 60 sec.).												
Direct Print	Canon Direct Print / Bubble Jet Direct / PictBridge compatible												
Display Languages	12 languages available for menus and messages (English, German, French, Dutch, Danish, Finnish, Italian, Norwegian, Swedish, Spanish, Chinese and Japanese)												

Specifications

My Camera Settings	The start-up image, start-up sound, shutter sound, operation sound and self-timer sound can be customized using the following methods: 1. Using the images and sounds recorded on a camera. 2. Using downloaded data from your computer using the supplied software.
Interface	USB (mini-B, PTP [Picture Transfer Protocol])
Power Source	1. Two AA-size alkaline batteries (included in the camera kit) 2. Two AA-size rechargeable NiMH batteries (sold separately) 3. AC Adapter Kit ACK800 (sold separately)
Operating Temperatures	0 – 40°C (32 – 104°F)
Operating Humidity	10 – 90%
Dimensions	110.0 x 58.0 x 36.6 mm (4.3 x 2.3 x 1.4 in.) (excluding protrusions)
Weight	Approx. 175 g (6.2 oz.) (excluding batteries and CF Card)

*¹ This digital camera supports Exif 2.2 (also called "Exif Print"). Exif Print is a standard for enhancing the communication between digital cameras and printers. By connecting to an Exif Print-compliant printer, the camera's image data at the time of shooting is used and optimized, yielding extremely high quality prints.

*² Recording time obtained when using the FC-32MH CF card (included with the camera) or the separately sold FC-256MH or FC-512MSH CF card (not sold in some regions).

Specifications

Battery Performance

	Number of Shots		Playback Time
	LCD Monitor On	LCD Monitor Off	
AA Alkaline Batteries (included with the camera)	Approx. 75 shots	Approx. 250 shots	Approx. 90 min.
AA NiMH Battery (NB-2AH)	Approx. 350 shots	Approx. 950 shots	Approx. 240 min.

*The data above reflects standard Canon testing conditions. The actual figures will vary according to the shooting conditions and settings.

<Test Conditions>

Shooting: Normal temperature (23 °C/73 °F), alternating the shots every 20 seconds, flash used once every four shots, power turned off and on again after every 8 shots.
 Playback: Normal temperature (23 °C/73 °F), continuous playback at 3 seconds per image.

- For information on handling batteries, see *Proper Battery Handling* (p. 16).

CF Cards and Estimated Capacities (Recordable Images)

CF card included with the camera

		FC-32MH	FC-64M	FC-128M	FC-256MH	FC-512MSH
L		18	38	76	154	308
		33	68	137	276	552
		67	136	274	548	1095
M1		30	61	122	246	491
		54	109	219	440	879
		108	217	435	868	1734
M2		53	107	215	431	855
		94	189	379	762	1522
		174	349	700	1390	2714
S		120	241	482	962	1891
		196	393	788	1563	3122
		337	676	1355	2720	5203
Movie		30 sec.	61 sec.	124 sec.	249 sec.	499 sec.
		91 sec.	183 sec.	368 sec.	735 sec.	1451 sec.
		242 sec.	486 sec.	973 sec.	1954 sec.	3902 sec.

- The maximum movie clip length is approximately 30 sec. (160) * or 3 min. (320, 640). The times shown are the maximum continuous recording times.
* When using the FC-32MH CF card (included), the separately sold FC-256MH or FC-512MSH CF card (not sold in some regions).
- (Superfine), (Fine) and (Normal) indicate the compression setting.
- L (Large), M1 (Medium 1), M2 (Medium 2), S (Small), (320), (640) and (160) show resolution rates.
- Some CF cards are not sold in some regions.

L (Large)	2048 x 1536 pixels
M1 (Medium 1)	1600 x 1200 pixels
M2 (Medium 2)	1024 x 768 pixels
S (Small)	640 x 480 pixels
(640)	640 x 480 pixels
(320)	320 x 240 pixels
(160)	160 x 120 pixels

Image File Size (Estimated)

	(Superfine)	(Fine)	(Normal)
L (2048 x 1536 pixels)	1602 KB	893 KB	445 KB
M1 (1600 x 1200 pixels)	1002 KB	558 KB	278 KB
M2 (1024 x 768 pixels)	570 KB	320 KB	170 KB
S (640 x 480 pixels)	249 KB	150 KB	84 KB
Movie	(640) (640 x 480 pixels)	990 KB/sec.	
	(320) (320 x 240 pixels)	330 KB/sec.	
	(160) (160 x 120 pixels)	120 KB/sec.	

Specifications

NiMH Battery NB-2AH

Supplied with the separately sold NiMH Battery NB4-200 set and the Battery/Charger Kit CBK4-200.

Type	Rechargeable nickel metal hydride battery
Nominal Voltage	1.2 V DC
Typical Capacity	2300 mAh (min.: 2150 mAh)
Cycle Life	Approx. 300 times
Operating Temperatures	0 – 35 °C (32 – 95 °F)
Dimensions	Diameter: 14.5 mm (0.6 in.) Length: 50 mm (2 in.)
Weight	Approx. 29 g (1.0 oz.)

Battery Charger CB-4AH/CB-4AHE

Supplied with the optional Battery and Charger Kit CBK4-200.

Rated Input	100 – 240 V AC (50/60 Hz) /10W
Rated Output	565 mA* ¹ , 1275 mA* ²
Charging Time	Approx. 250 minutes* ¹ Approx. 110 minutes* ²
Operating Temperatures	0 – 35 °C (32 – 95 °F)

Dimensions	65.0 × 105.0 × 27.5 mm (2.6 × 4.1 × 1.1 in.)
Weight	CB-4AH: Approx. 95 g (3.4 oz.) CB-4AHE: Approx. 97 g (3.4 oz.)

*¹ To charge four NB-2AH NiMH Batteries
*² To charge two NB-2AH NiMH Batteries loaded one at each end of the battery charger

Compact Power Adapter CA-PS800

Supplied with the separately sold AC Adapter Kit ACK800.

Rated Input	100 – 240 V AC (50/60 Hz), 16 VA (100 V) – 26 VA (240 V)
Rated Output	3.15 V DC/2 A
Operating Temperatures	0 – 40 °C (32 – 104 °F)
Dimensions	42.5 × 104 × 31.4 mm (1.7 × 4.1 × 1.3 in.)
Weight (body)	Approx. 180 g (6.4 oz.)

CompactFlash™ Card

Card slot type	Type 1
Dimensions	36.4 × 42.8 × 3.3 mm (1.4 × 1.7 × 0.1 in.)
Weight (body)	Approx. 10 g (0.4 oz.)

Photo Tips and Information

This section offers photography tips.

Tip for Using the Self-timer (p. 41)

Normally, the camera shakes a little when you press the shutter button.

Setting the self-timer to  delays the shutter release for two seconds and allows the camera to stop shaking, thus preventing a blurred image. Even better results can be obtained by placing the camera on a stable surface or by using a tripod to shoot.

How to Adjust the Exposure (p. 65)

This camera automatically adjusts the exposure to shoot images with the optimal brightness.

However, recorded images may sometimes be brighter or darker than the actual image depending on the shooting conditions. If this happens, adjust the exposure compensation manually.

Underexposure

The whole recorded image is dark, which makes white elements of the image appear gray. Shooting bright subjects or in backlit conditions may cause the image to be underexposed. Adjust the exposure compensation towards the + end.



Optimal Exposure



Overexposure

The whole recorded image is bright, which makes black elements of the image appear gray. Shooting dark subjects or in dark places may cause the image to be overexposed. Adjust the exposure compensation towards the - end.



ISO Speed (p. 69)

The ISO speed is the numeric representation of the camera's sensitivity to light. The higher the ISO speed, the higher the sensitivity. A high ISO speed allows you to shoot images in dark indoor or outdoor conditions without a flash and also helps prevent blurred images due to camera shake. This is convenient when shooting images in places where flash photography is prohibited. The ISO speed setting makes full use of the available light, resulting in images that convey the feel of the place they were shot.



ISO 50 equivalent



ISO 400 equivalent

Index

A

AF	33
AF-assist Beam	33

B

Batteries	
Battery Performance	114
Battery Status Indications	18
Installing	15
Proper Battery Handling	16

C

Camera Care and Maintenance	110
CF Card Slot/Battery Cover	13
CF Cards	
About CF Cards	19
CF Cards and Estimated Capacities (Recordable Images)	114
Formatting	18
Compression	36
Computer System Requirements	84
Continuous Mode	41

D

Date	20
Date Battery	105

DC IN Terminal	12, 109
Default	62
Default Settings	57
DIGITAL Terminal	12, 86
Digital Zoom	31
Direct Transfer	88
Downloading Images to a Computer	
Connecting the camera to a computer	84
Downloading directly from a CF card	91
Using a PC card reader or a PC card slot	91
DPOF	78

E

Erasing	
Erasing All Images	53
Erasing Single Images	53
Exposure Compensation	65

F

File Number	92
File Size	115
Flash	38
Focus Lock	63
FUNC. Menu	54
Functions	124

Index

I

Image Transmission Settings (DPOF Transfer Order)	82
Index Playback	48
Indicator	14
Infinity	40
ISO Speed	69

L

LCD Monitor	
Using	26
Light Metering Modes	65

M

Macro	40
Magnifying Images	47
Menus	50
Microphone	12, 45
Movie	
Editing	50
Movie Mode	45
Recording	45
Sound Memos	73
Viewing	49
My Camera Settings	61

P

Photo Effect	70
Playback	
Auto Play	74
Displaying Images Individually	47
Rotating Images in the Display	72
Viewing Images in Sets of Nine	48
Play Menu	58
Power Saving	24
Auto Power Off	24
Display Off	24
Pressing Fully	31
Pressing Halfway	31
Printing	76
Connecting the Camera to a Printer	77
DPOF Print Settings	78
Print Style	80
Printing	76
Resetting the Print Settings	81
Selecting Images for Printing	78
Print/Share button	14, 89
Protecting	75

R

Rec. Menu	57
Red-eye Reduction	38, 39

Red-eye Reduction Lamp 12, 39
 Replacing the Date Battery 105
 Resolution 36

S

Self-timer 41
 Set up Menu 58
 Setting
 AF-assist Beam 57
 AiAF 57
 Auto Power Down 60
 Display Off 60
 File No. Reset 60
 Format 60
 Mute 58
 Setting the Language 21
 Shooting 54
 Shutter Button 31
 Single Image Playback 47
 Sound Memo 73
 Speaker 13
 Stitch Assist
 Framing a Subject 43
 Shooting 43
 Strap 13

T

Terminal Cover 12, 86
 Time 20
 Turning the Power On/Off 23

U

Using the Power Kits..... 106

V

Viewfinder 32

W

White Balance 66

FCC Notice (Digital Camera, Model PC1203)

This device complies with Part 15 of the FCC Rules. Operation is subject to the following two conditions;

- (1) this device may not cause harmful interference, and
- (2) this device must accept any interference received, including interference that may cause undesired operation.

Note: This equipment has been tested and found to comply with the limits for Class B digital devices, pursuant to Part 15 of the FCC rules.

These limits are designed to provide reasonable protection against harmful interference in a residential installation.

This equipment generates, uses and can radiate radio frequency energy and, if not installed and used in accordance with the instructions, may cause harmful interference to radio communications. However, there is no guarantee that interference will not occur in a particular installation. If this equipment does cause harmful interference to radio or television reception, which can be determined by turning the equipment off and on, the user is encouraged to try to correct the interference by one or more of the following measures:

- Reorient or relocate the receiving antenna.
- Increase the separation between the equipment and receiver.
- Connect the equipment into an outlet on a circuit different from that to which the receiver is connected.
- Consult the dealer or an experienced radio/TV technician for help.

The cables with the ferrite core provided with the digital camera must be used with this equipment in order to comply with Class B limits in Subject B of Part 15 on the FCC rules.

Do not make any changes or modifications to the equipment unless otherwise specified in the manual. If such changes or modifications should be made, you could be required to stop operation of the equipment.

Canon U.S.A. Inc.

One Canon Plaza, Lake Success, NY 11042, U.S.A.
Tel No. (516) 328-5600

Canadian Radio Interference Regulations

THIS CLASS B DIGITAL APPARATUS MEETS ALL REQUIREMENTS OF THE CANADIAN INTERFERENCE CAUSING EQUIPMENT REGULATIONS.

























Réglementation canadienne sur les interférences radio

CET APPAREIL NUMERIQUE DE LA CLASSE B RESPECTE TOUTES LES EXIGENCES DU REGLEMENT SUR LE MATERIEL BROUILLEUR DU CANADA.



Functions Available in Each Shooting Mode

The following chart shows the functions and settings available in each shooting mode.

Function				 		Reference Pages
Resolution	Large  * Medium 1 	○	○	△	–	36
	Medium 2  Small 	–	–	–	○	
	Movie   * 	–	–	–	○	
Compression	Superfine 	○	○	△	–	37
	Fine 	○*	○*	○*	–	
	Normal 	○	○	△	–	
Flash	Auto 	○	○	–	–	38
	Auto with Red-eye Reduction 	○*	○*	–	–	
	On 	–	○	△	–	
	Off 	○	○	△*	–	
Slow Synchro 	–	○	△	–		
Macro Mode		○	○	△	○	40
Infinity Mode		–	○	△	○	40
Shooting Method	Single 	○*	○*	△*	○*	31
	Continuous 	–	○	–	–	41
	Self-timer 	○	○	△	○	41



Function					Reference Pages
Exposure Compensation	–	○	△	○	65
Light Metering System	Evaluative Metering	–	○*	–	65
	Center-Weighted Averaging	–	○	–	
	Spot Metering	–	○	–	
White Balance (1)	_(2)	○	△	○	66
Photo Effect	–	○	△	○	70
ISO Speed	_(3)	○	_(3)	_(3)	69
AF Frame	–	○	–	–	64
Digital Zoom	○	○	–	–	31
AF-assist Beam	○	○	△	○	33

* : Default settings ○ : Available △ : Available only for the first image – : Not available
 : Setting remains in effect even when the camera is turned off.

The default for the settings changed by the menu and button operations can be restored all at once except for Shooting mode, [Date/Time] and [Language] (p. 62).

(1)Cannot be adjusted when the photo effect is set to [Sepia] or [B/W].

(2)The white balance is set to [AUTO].

(3)The camera will automatically select the setting.